

Graphical Models

Discrete Inference and Learning

Lecture 2

MVA

2019 – 2020

<http://thoth.inrialpes.fr/~alahari/disinflern>

Practical matters

- Course website
 - <http://thoth.inrialpes.fr/~alahari/disinflearn>
 - (linked from my webpage)
- Mailing list
- Questions ?

Project suggestions

- Implement BP on trees, then graph, extend to TRW, compare
- Implement graph cut + extension (Ishikawa, other multi-label) or variation of implementation + small application
- Complex application of graph cut, requiring modelling (e.g., sequence of images)
- Geometric scene labelling with graph cuts
- Joint modelling of two labelling problems (e.g., segmentation + detection)
- Implement fast primal-dual algorithm + evaluate
- Implement deformable parts model for object detection
- ...

- Or your own (but check with us first)

Recap: Lecture 1

- Graphical Models
 - Making **global** predictions from **local** observations
 - Learning from large quantities of data
- Two types of models studied in the class
 - Bayesian nets
 - Markov nets

Recap: Lecture 1

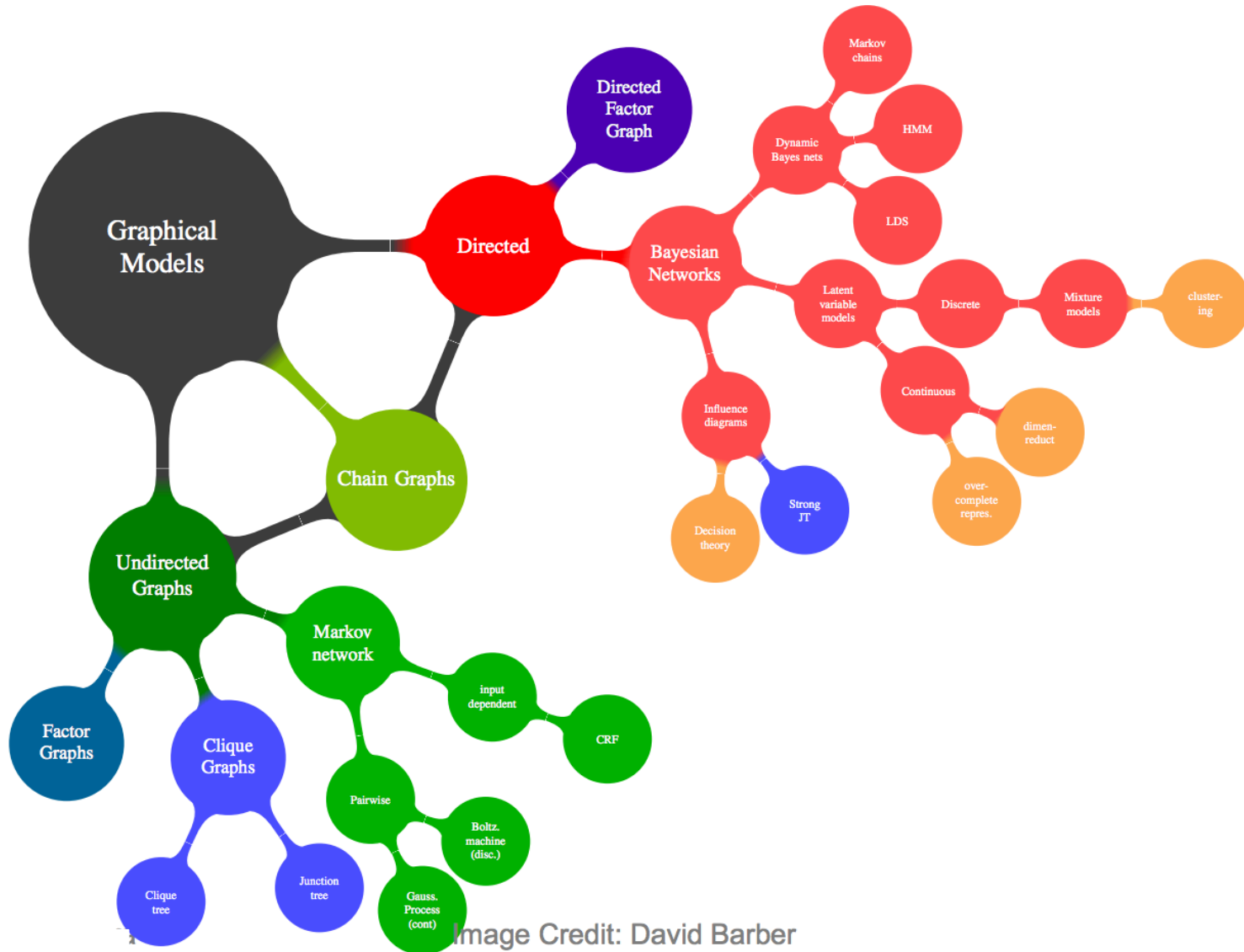

Image Credit: David Barber

Recap: Lecture 1

- Question: What is the core of these models?
- Question: Can you compute probabilities in Markov nets? If yes, how and if no, why?
- Question: What is the difference between Markov and Conditional random fields?

A Computer Vision Application

Binary Image Segmentation



How ?

Cost function Models *our* knowledge about natural images

Optimize cost function to obtain the segmentation

A Computer Vision Application

Binary Image Segmentation

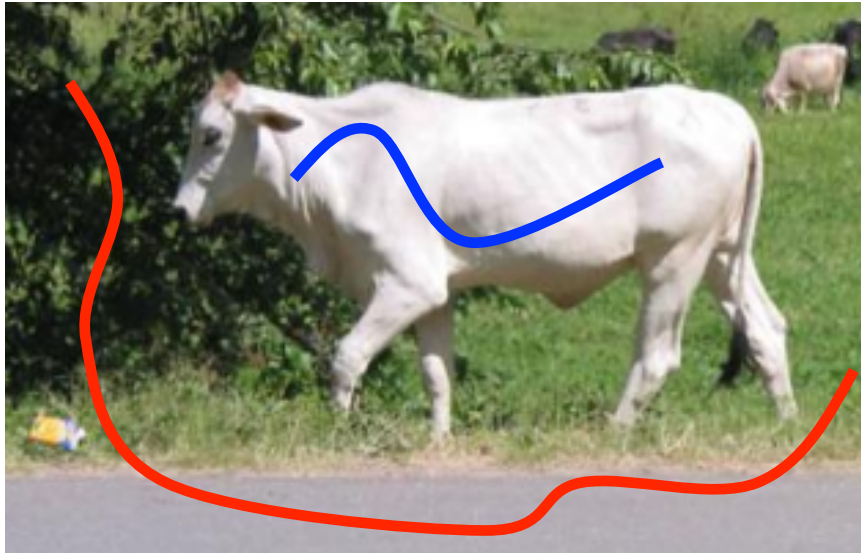

Object - white, Background - green/grey

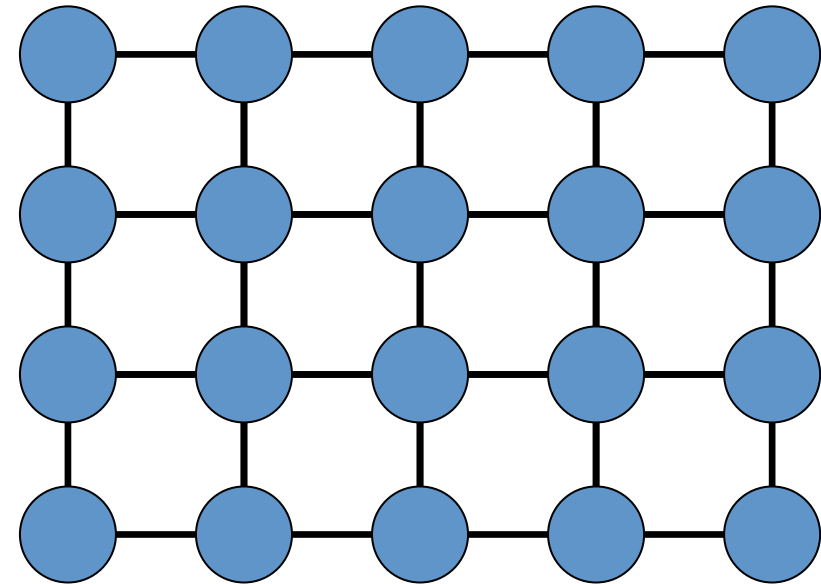

Graph $G = (V, E)$

Each vertex corresponds to a pixel

Edges define a 4-neighbourhood *grid* graph

Assign a label to each vertex from $L = \{\text{obj}, \text{bkg}\}$

A Computer Vision Application

Binary Image Segmentation

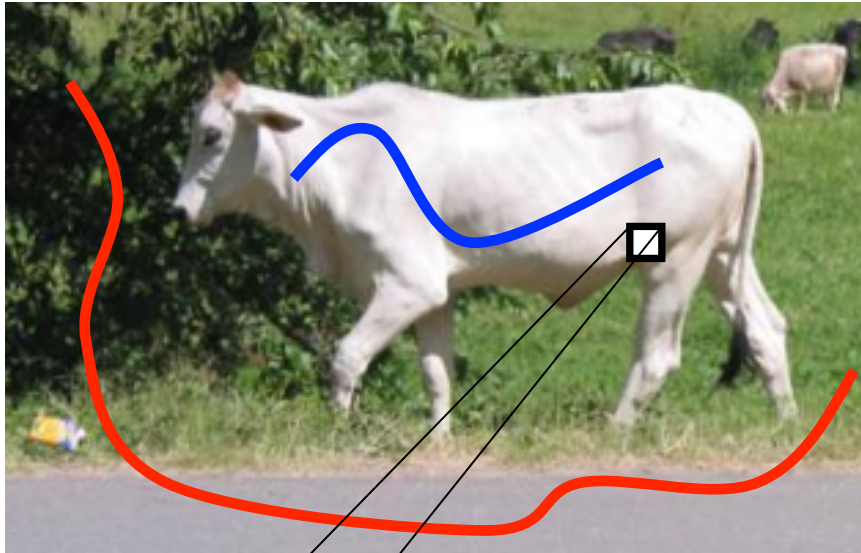

Object - white, Background - green/grey

Cost of a labelling $f : V \rightarrow L$

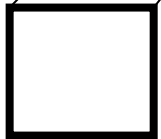

Cost of label 'obj' low Cost of label 'bkg' high

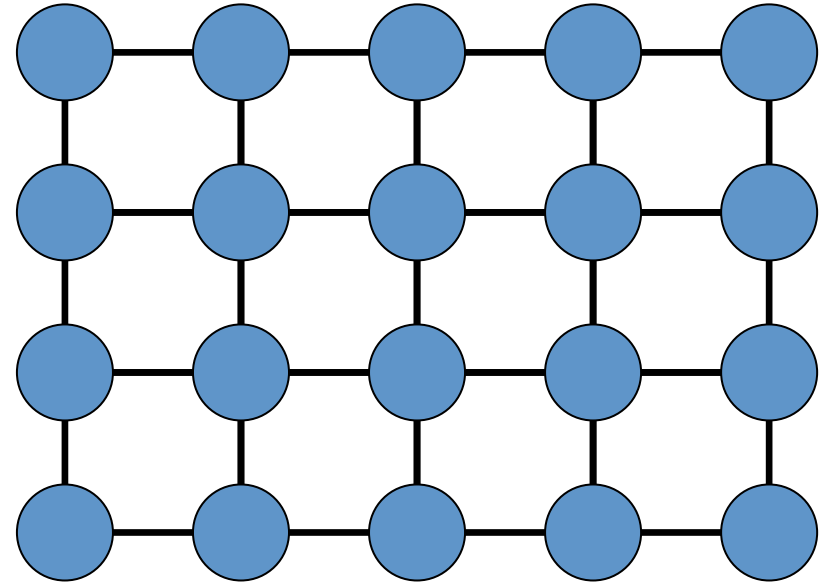

Graph $G = (V, E)$

Per Vertex Cost

A Computer Vision Application

Binary Image Segmentation

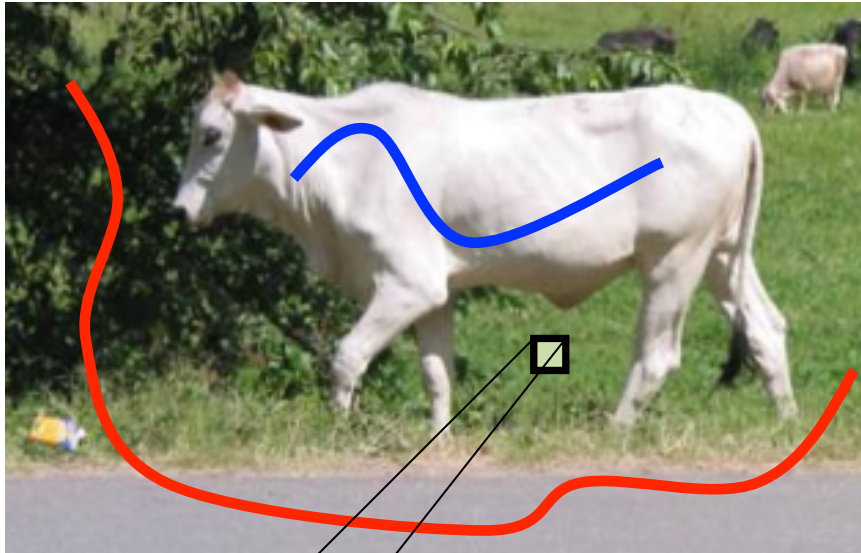

Object - white, Background - green/grey

Cost of a labelling $f : V \rightarrow L$



Cost of label 'obj' high Cost of label 'bkg' low

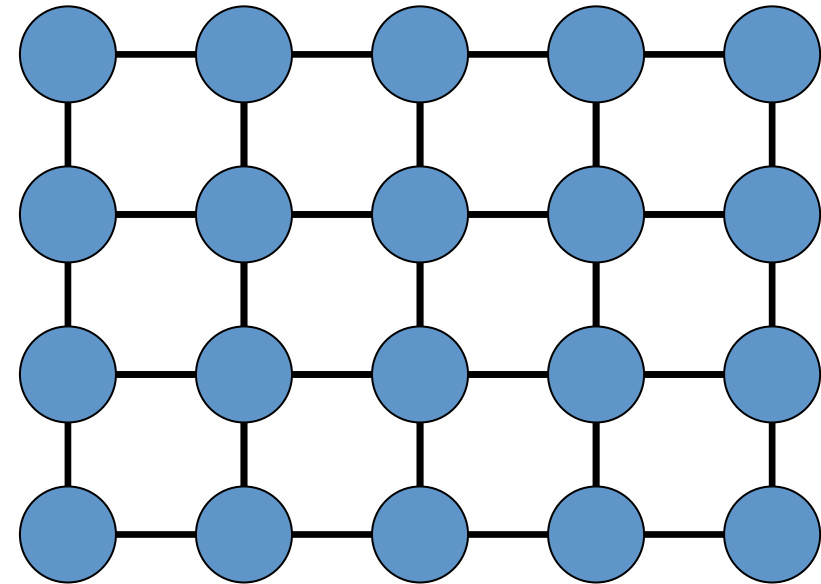

Graph $G = (V, E)$

Per Vertex Cost

UNARY COST

A Computer Vision Application

Binary Image Segmentation

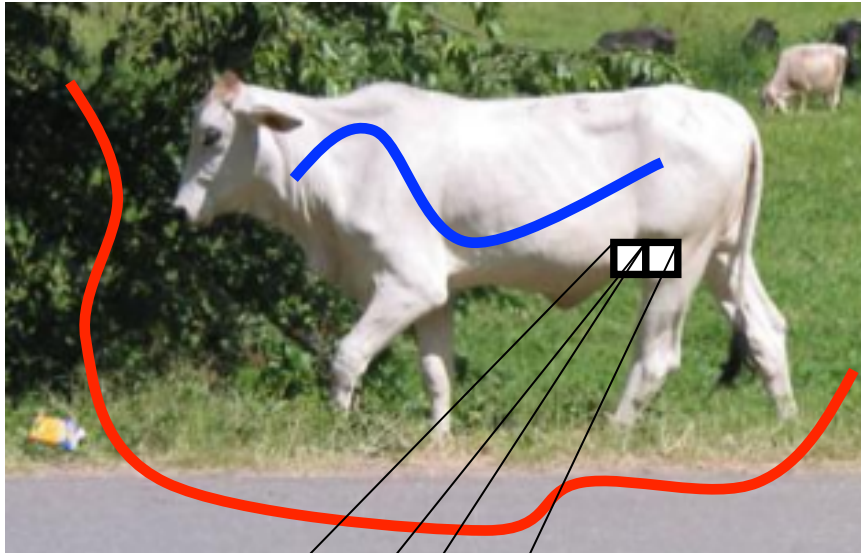

Object - white, Background - green/grey

Cost of a labelling $f : V \rightarrow L$



Cost of same label low

Cost of different labels high

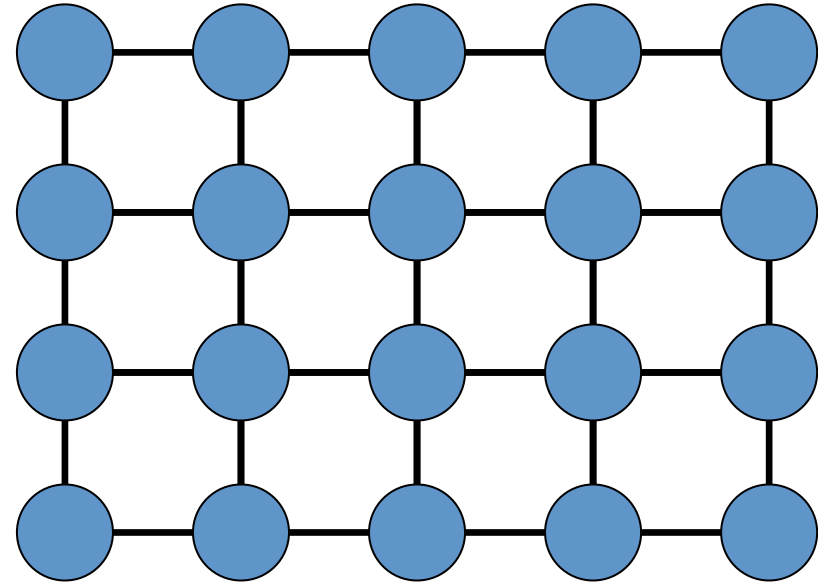

Graph $G = (V, E)$

Per Edge Cost

A Computer Vision Application

Binary Image Segmentation

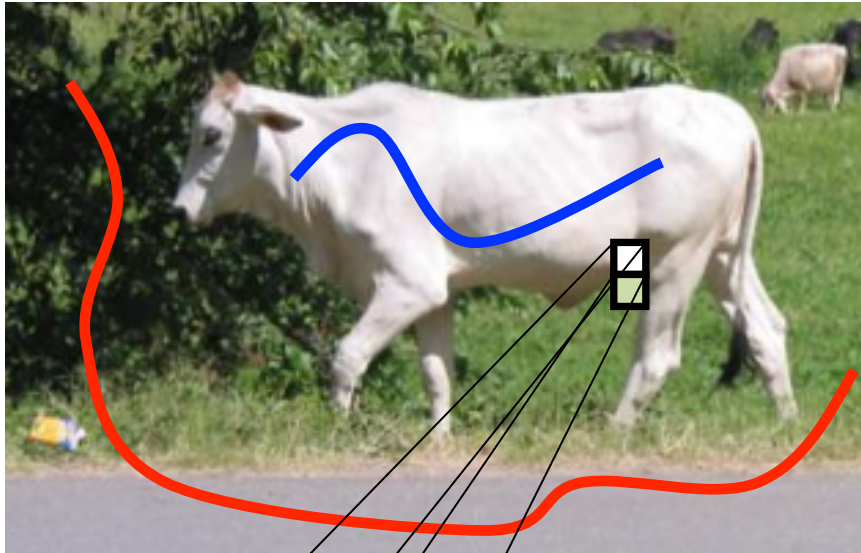

Object - white, Background - green/grey

Cost of a labelling $f : V \rightarrow L$



Cost of same label high

Cost of different labels low

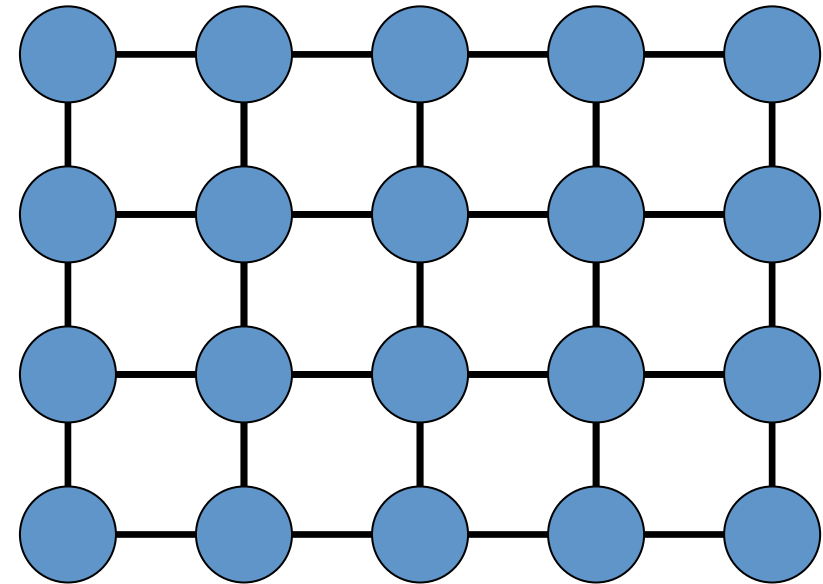

Graph $G = (V, E)$

Per Edge Cost

**PAIRWISE
COST**

A Computer Vision Application

Binary Image Segmentation

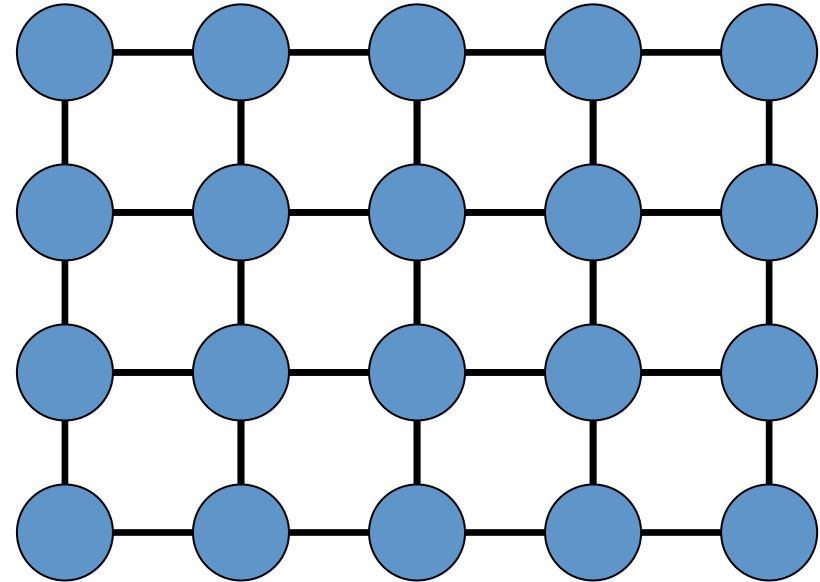

Graph $G = (V, E)$

Problem: Find the labelling with minimum cost f^*

Another Computer Vision Application

Stereo Correspondence

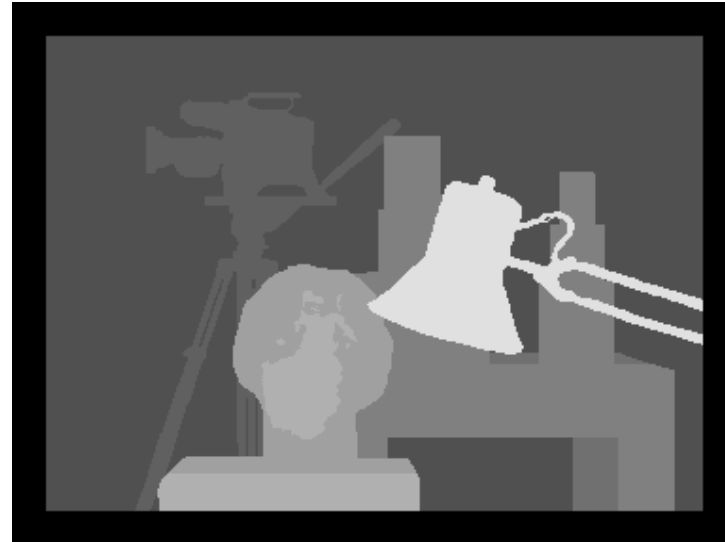
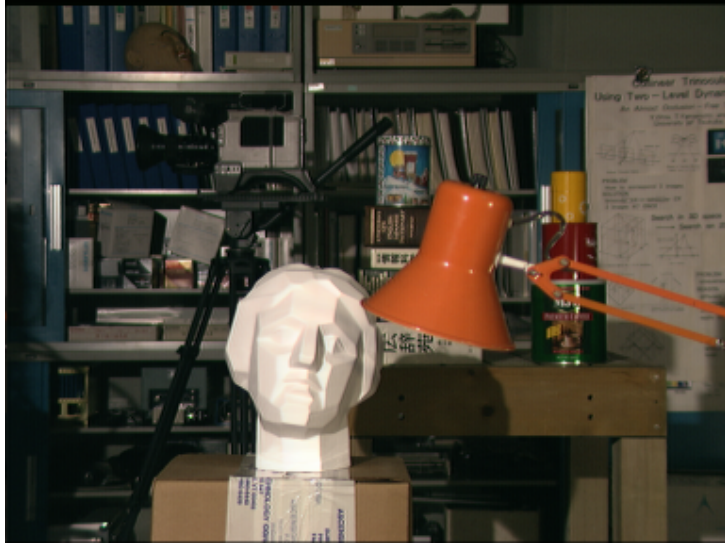

Disparity Map

How ?

Minimizing a cost function

Another Computer Vision Application

Stereo Correspondence

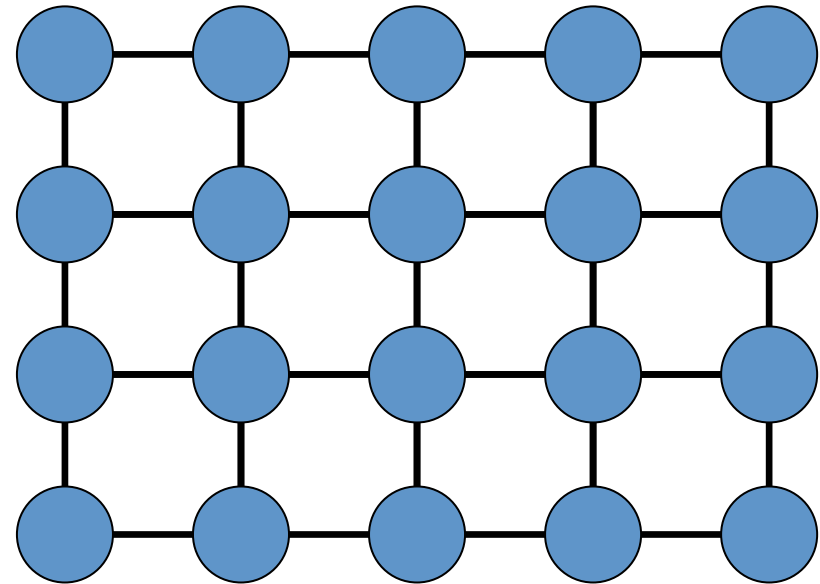

Graph $G = (V, E)$

Vertex corresponds to a pixel

Edges define grid graph

$L = \{\text{disparities}\}$

Another Computer Vision Application

Stereo Correspondence



Cost of labelling f :

Unary cost + Pairwise Cost

Find minimum cost f^*

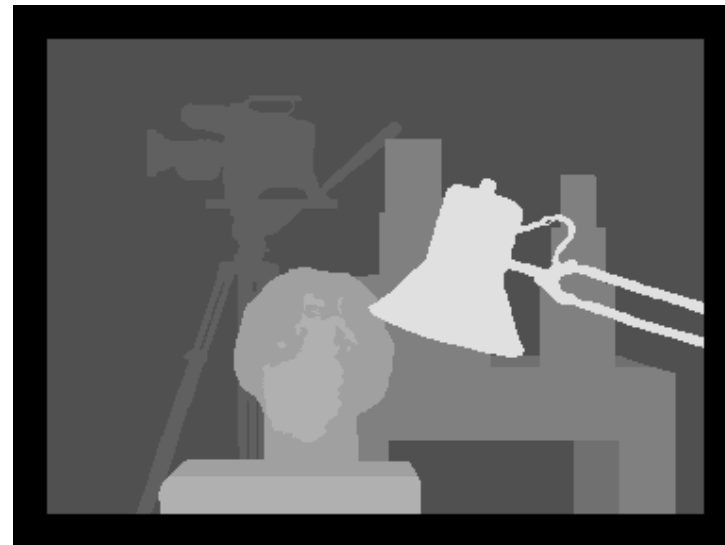

The General Problem

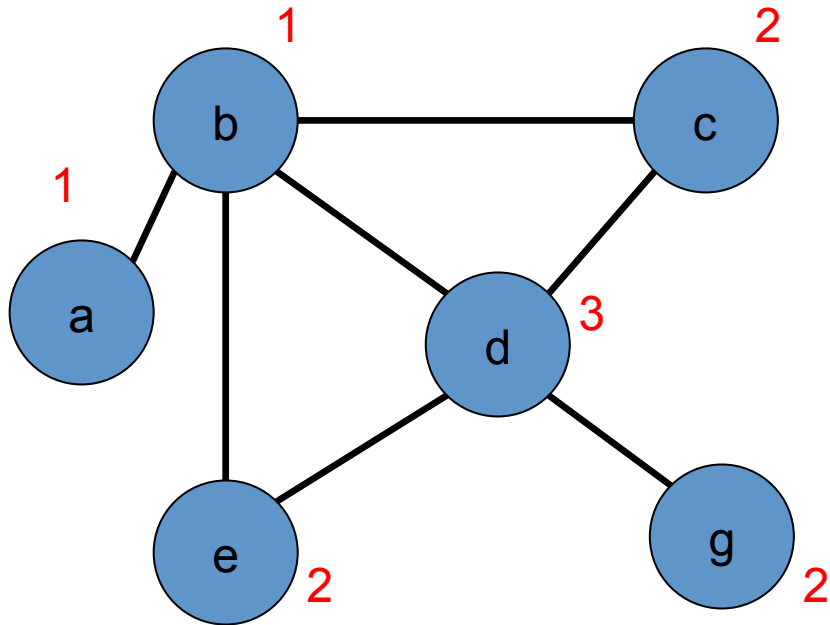

Graph $G = (V, E)$

Discrete label set $L = \{1, 2, \dots, h\}$

Assign a label to each vertex

$f: V \rightarrow L$

Cost of a labelling $Q(f)$

Unary Cost

Pairwise Cost

Find $f^* = \arg \min Q(f)$

Overview

- Basics: problem formulation
 - Energy Function
 - MAP Estimation
 - Computing min-marginals
 - Reparameterization
- Solutions
 - Belief Propagation and related methods [Lecture 2]
 - Graph cuts [Lecture 3]

Energy Function

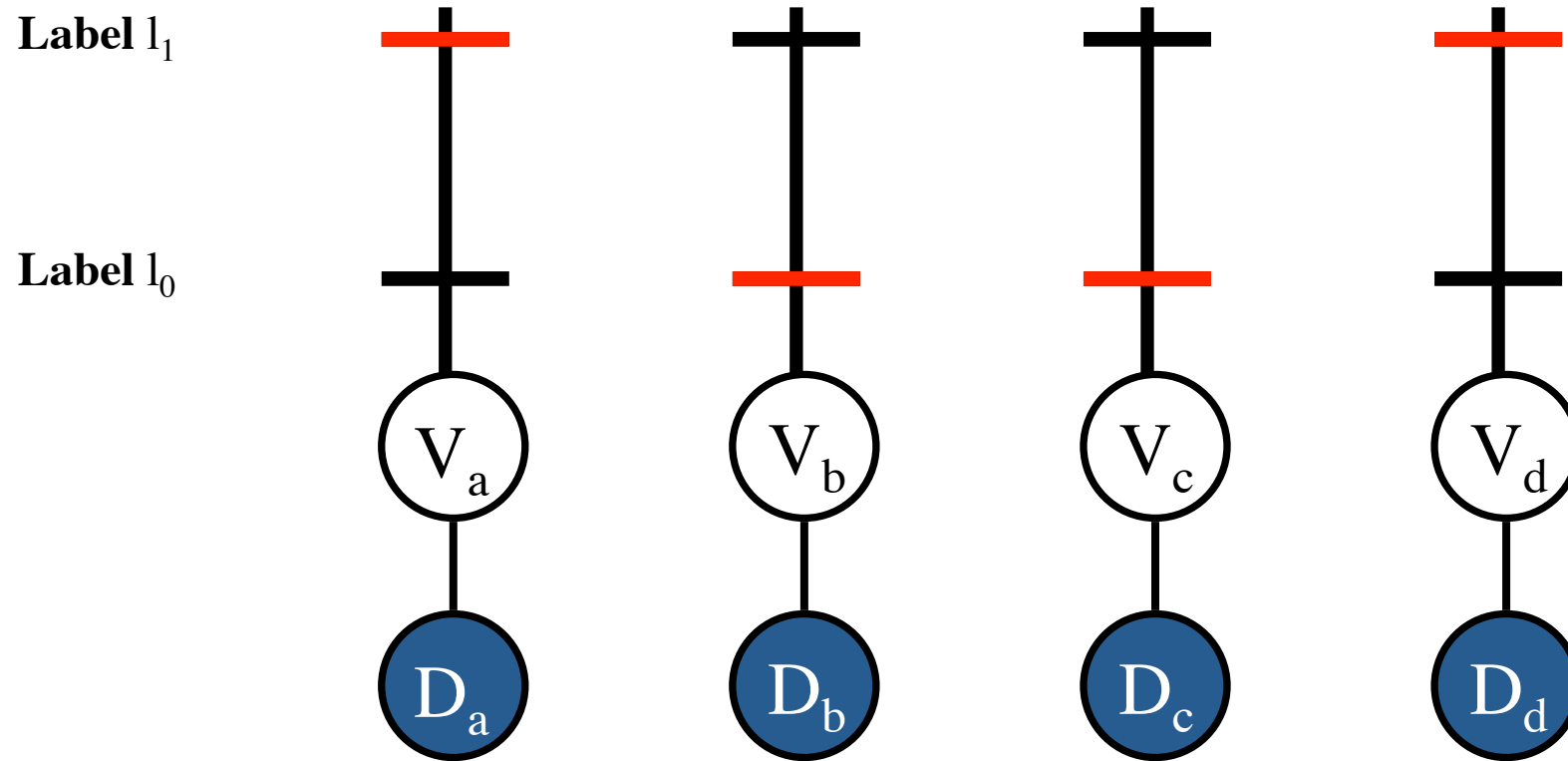

Random Variables $V = \{V_a, V_b, \dots\}$

Labels $L = \{l_0, l_1, \dots\}$ Data D

Labelling $f: \{a, b, \dots\} \rightarrow \{0, 1, \dots\}$

Energy Function

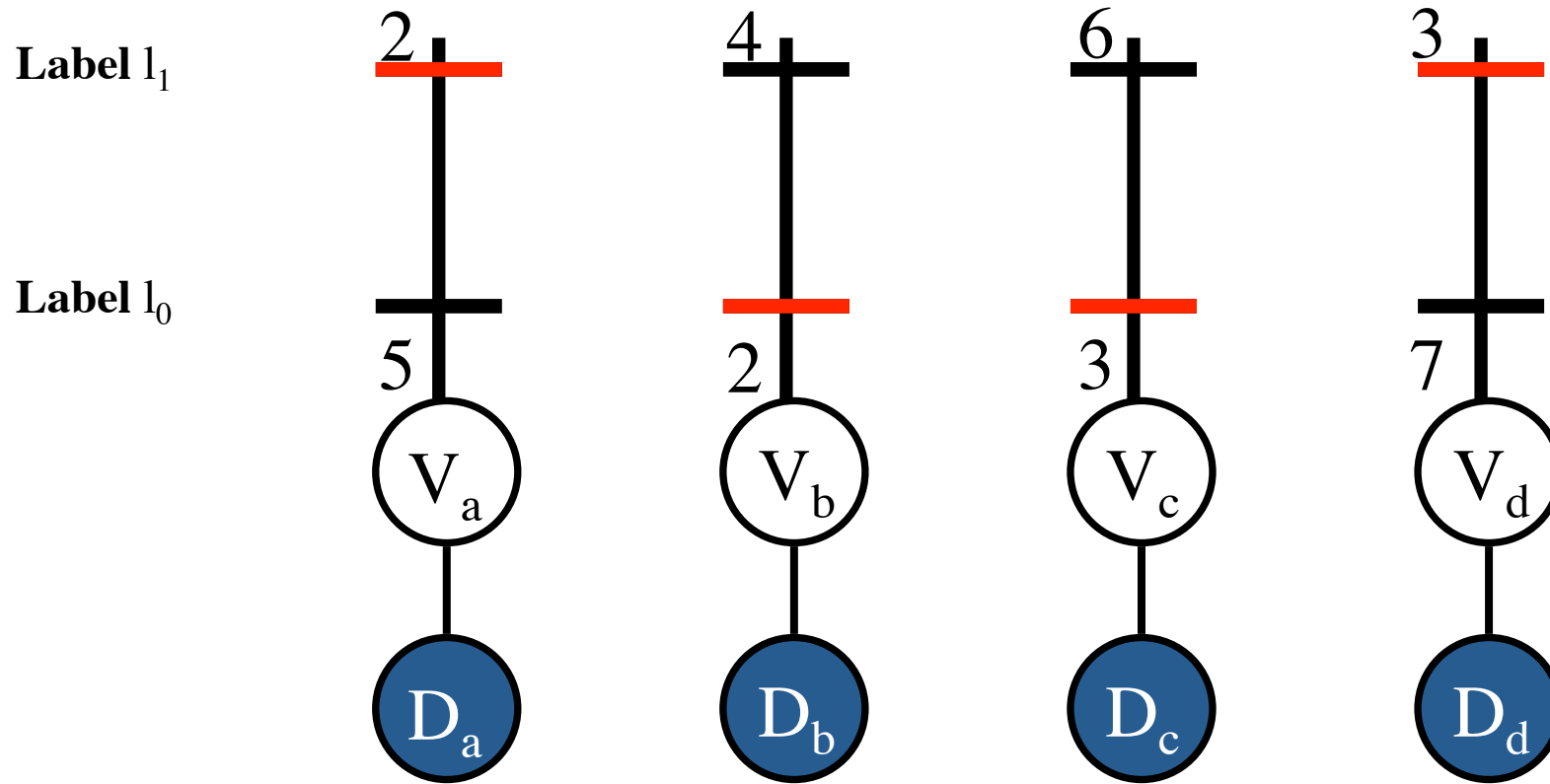

$$Q(f) = \sum_a \theta_{a;f(a)}$$

Unary Potential

Easy to minimize

Neighbourhood

Energy Function

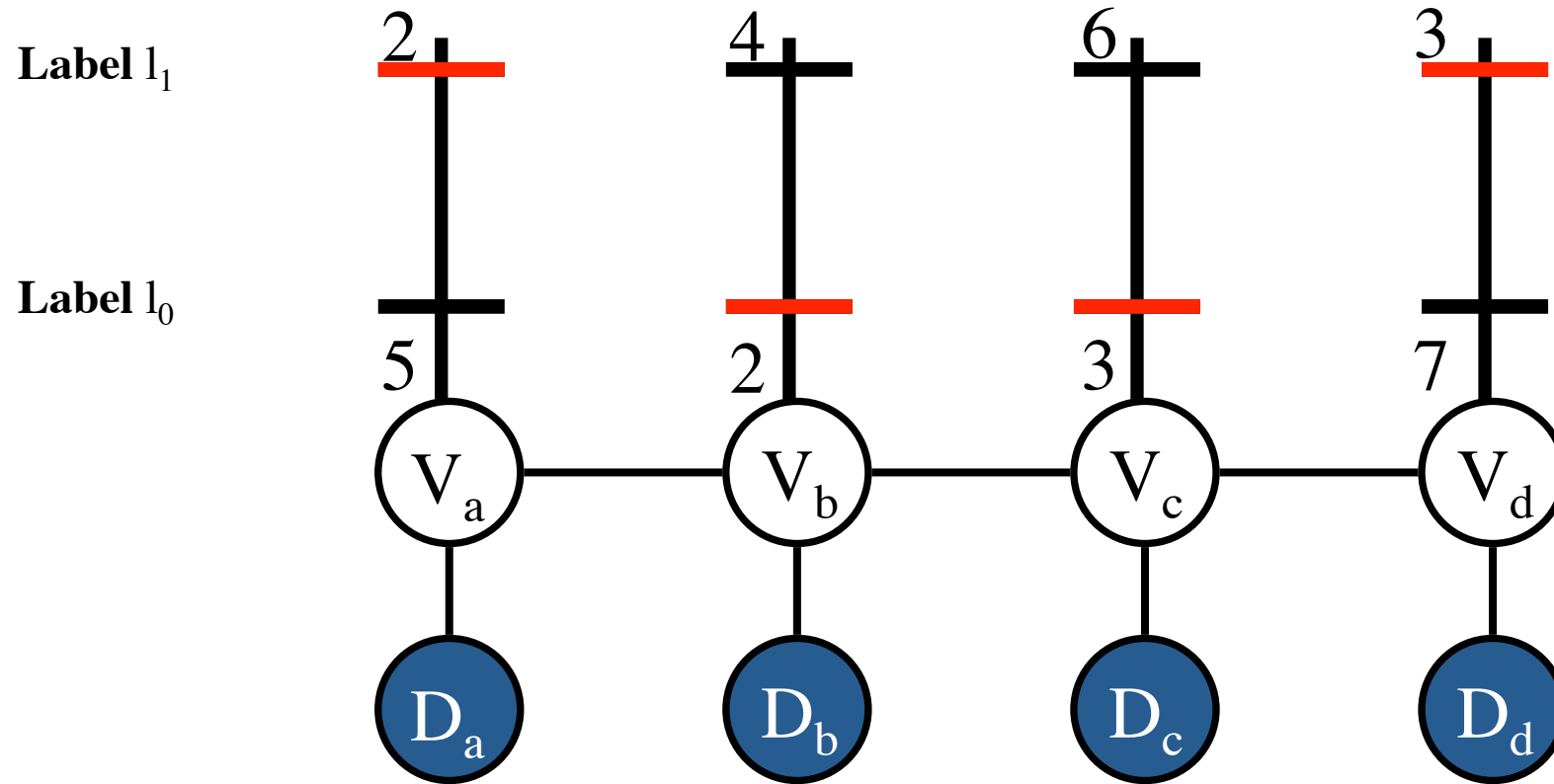

$E : (a,b) \in E$ iff V_a and V_b are neighbours

$$E = \{ (a,b) , (b,c) , (c,d) \}$$

Energy Function

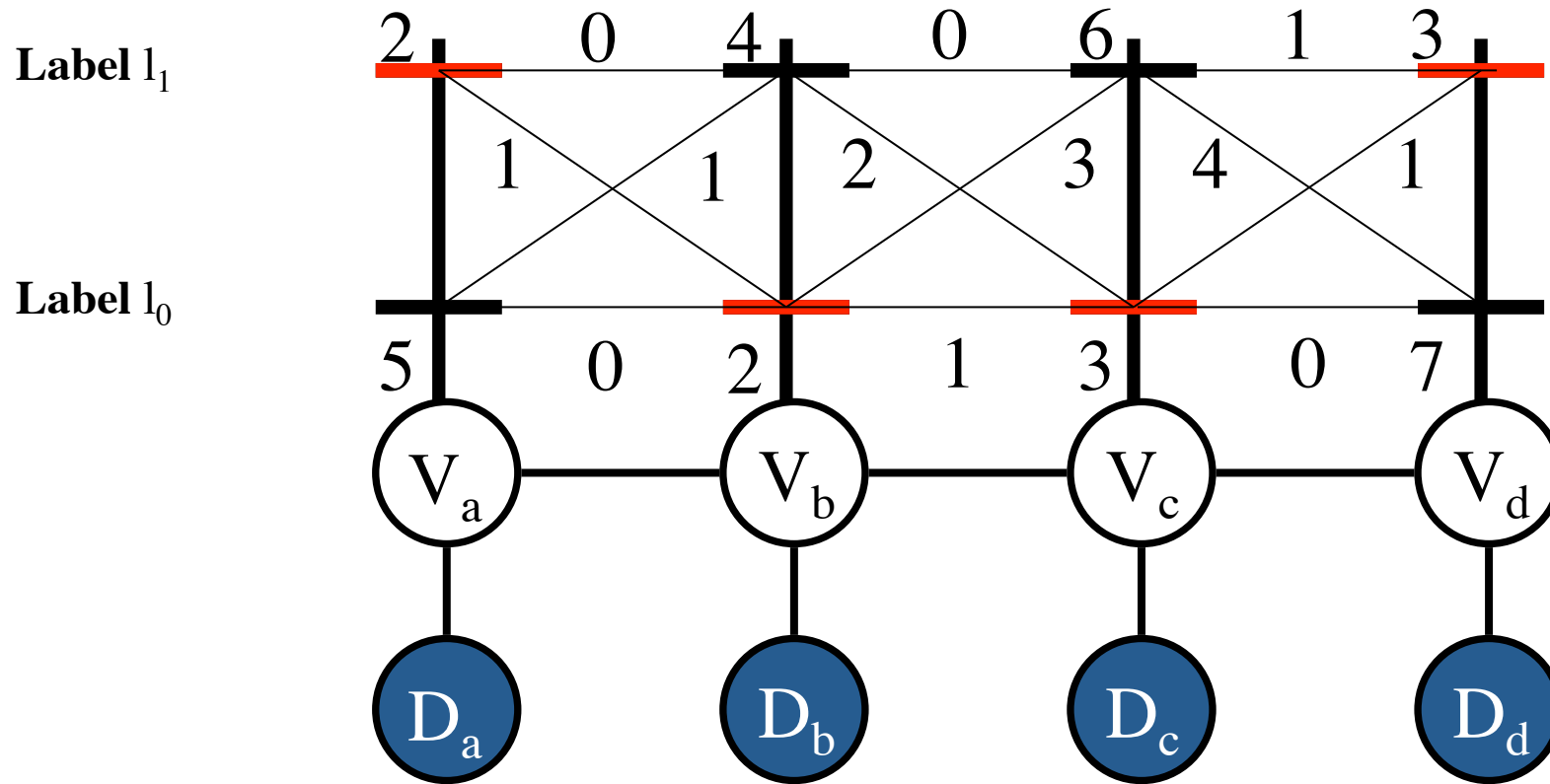

Pairwise Potential

$$Q(f) = \sum_a \theta_{a;f(a)} + \sum_{(a,b)} \theta_{ab;f(a)f(b)}$$

Energy Function

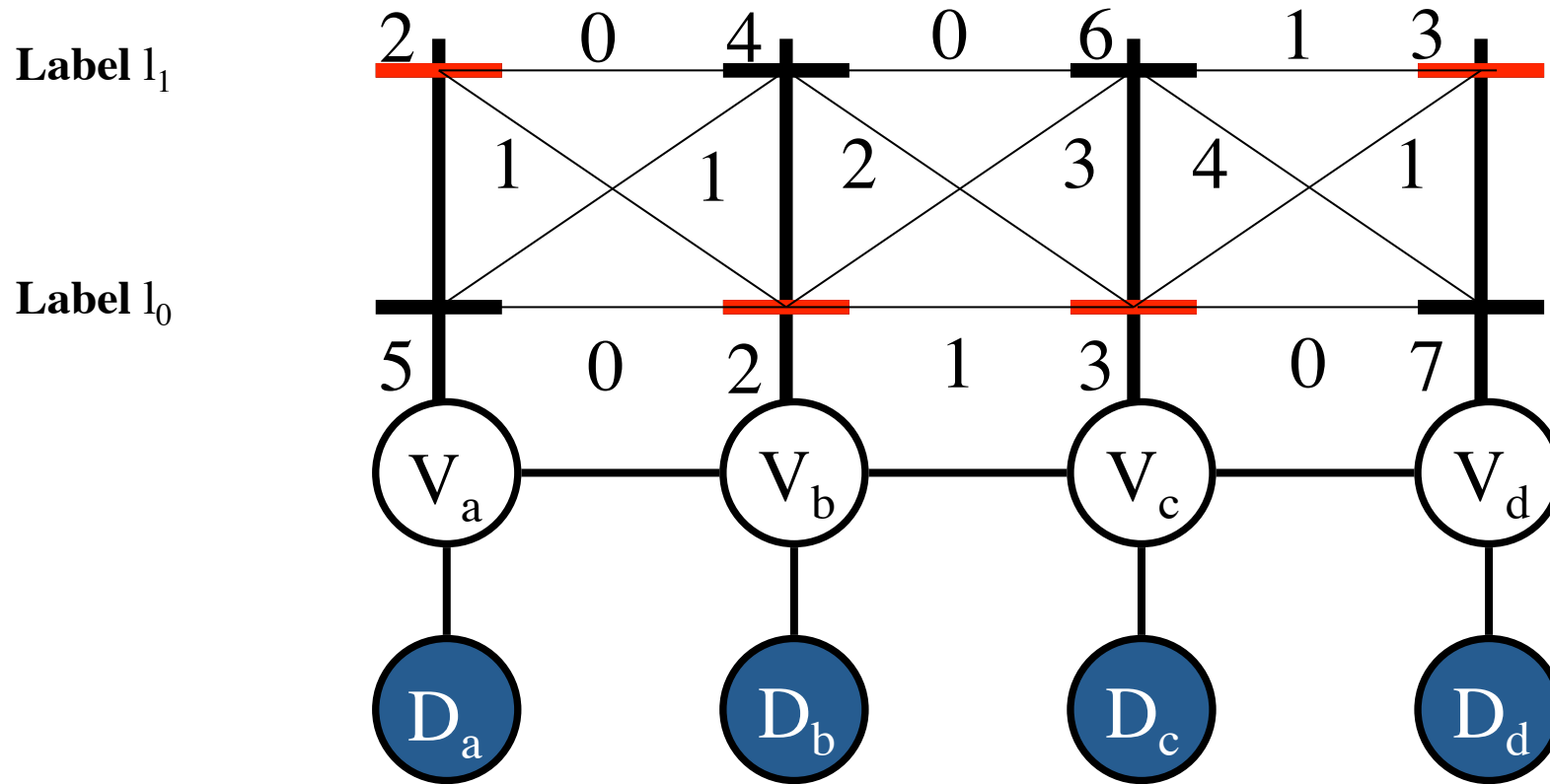

$$Q(f; \theta) = \sum_a \theta_{a;f(a)} + \sum_{(a,b)} \theta_{ab;f(a)f(b)}$$

Parameter

Overview

- Basics: problem formulation
 - Energy Function
 - MAP Estimation
 - Computing min-marginals
 - Reparameterization
- Solutions
 - Belief Propagation and related methods [Lecture 2]
 - Graph cuts [Lecture 3]

MAP Estimation

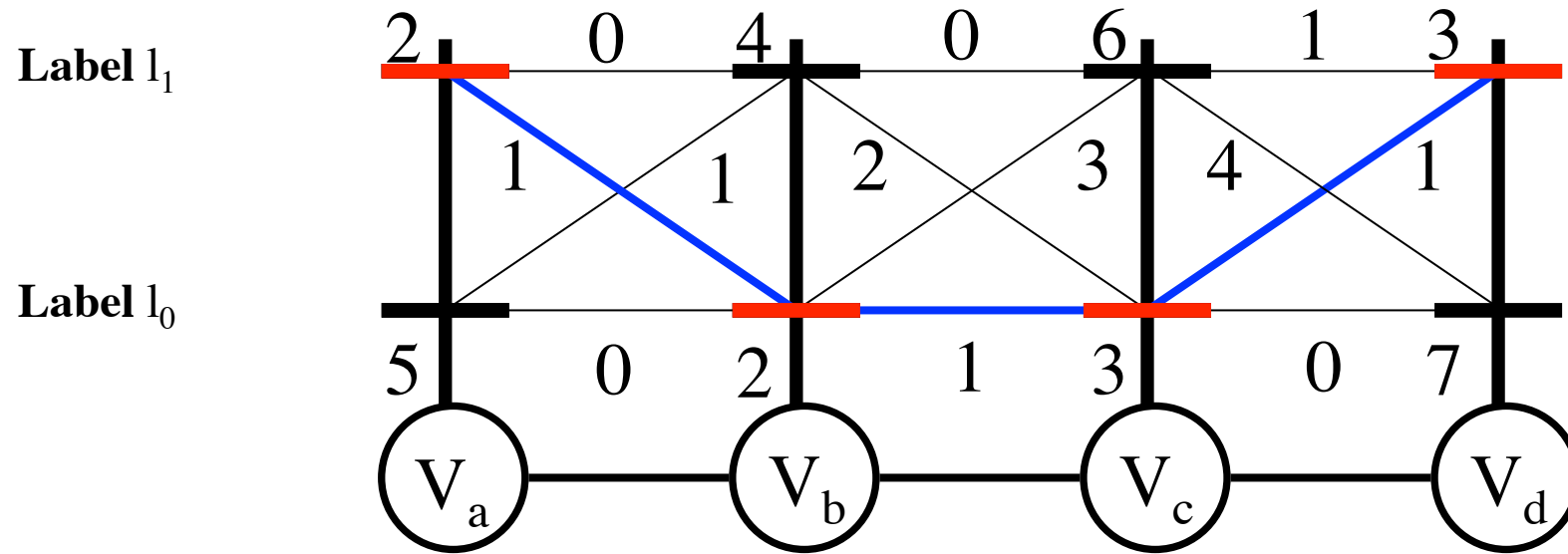

$$Q(f; \theta) = \sum_a \theta_{a;f(a)} + \sum_{(a,b)} \theta_{ab;f(a)f(b)}$$

$$2 + 1 + 2 + 1 + 3 + 1 + 3 = 13$$

MAP Estimation

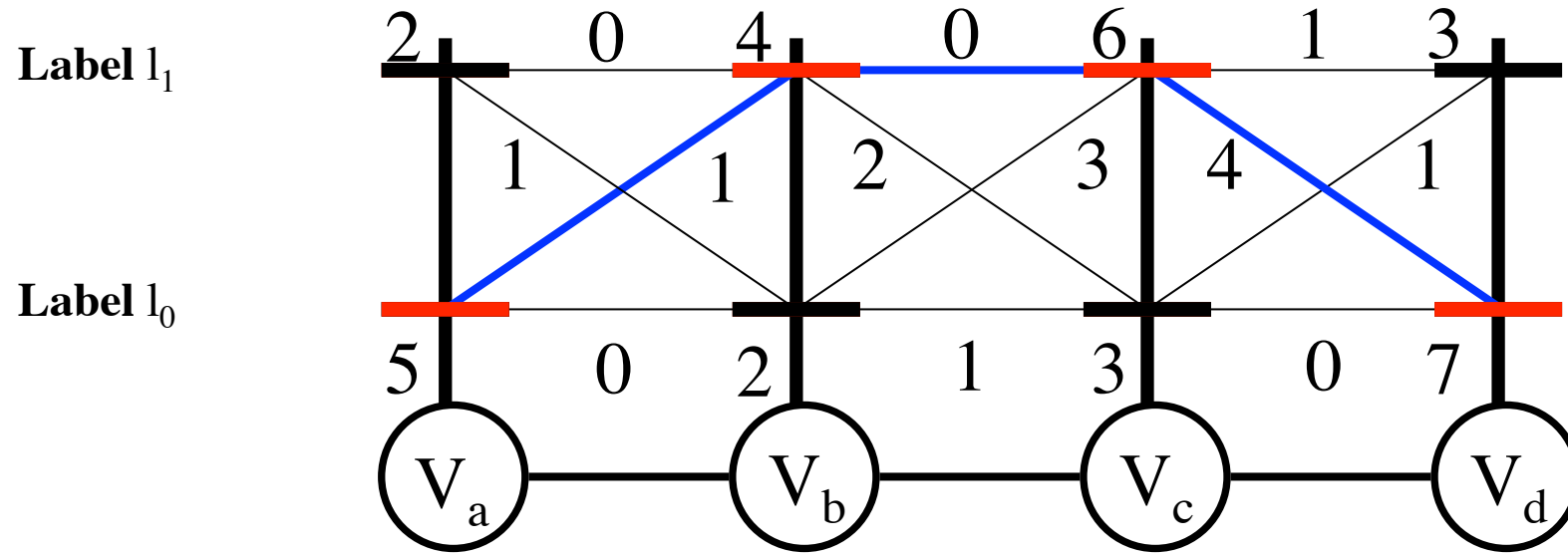

$$Q(f; \theta) = \sum_a \theta_{a;f(a)} + \sum_{(a,b)} \theta_{ab;f(a)f(b)}$$

$$5 + 1 + 4 + 0 + 6 + 4 + 7 = 27$$

MAP Estimation

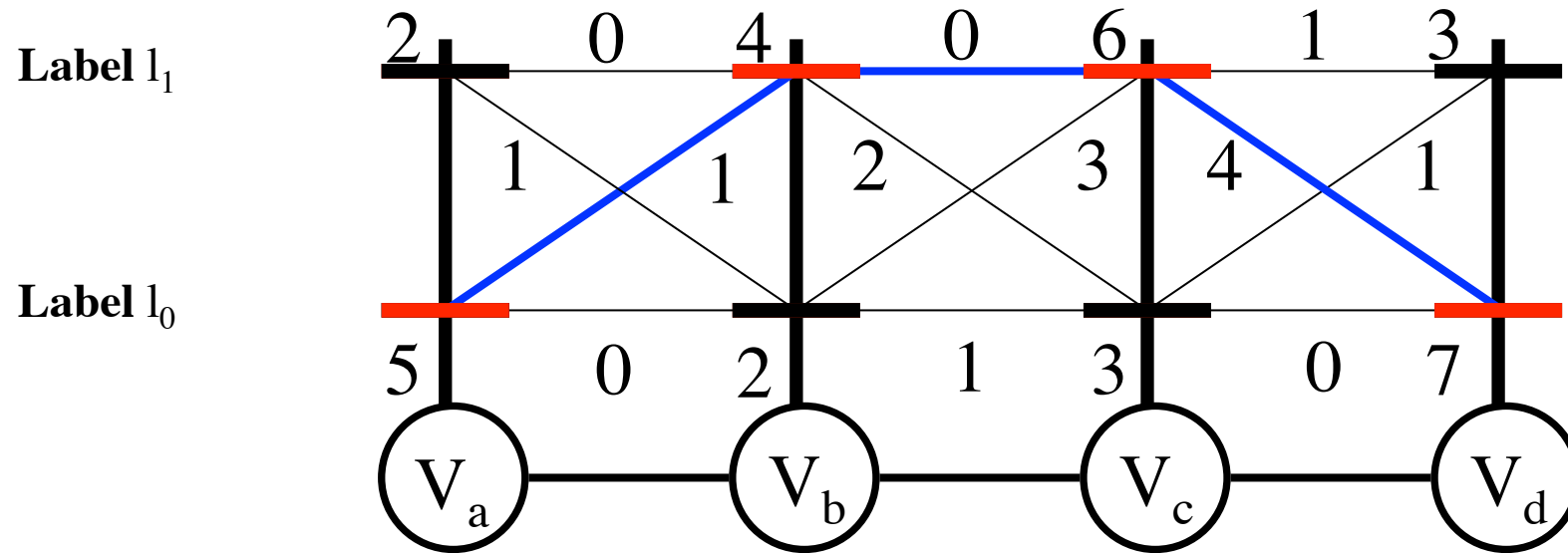

$$q^* = \min Q(\mathbf{f}; \theta) = Q(\mathbf{f}^*; \theta)$$

$$Q(\mathbf{f}; \theta) = \sum_a \theta_{a;f(a)} + \sum_{(a,b)} \theta_{ab;f(a)f(b)}$$

$$\mathbf{f}^* = \arg \min Q(\mathbf{f}; \theta)$$

Equivalent to maximizing the associated probability

MAP Estimation

16 possible labellings

$$f^* = \{1, 0, 0, 1\}$$

$$q^* = 13$$

f(a)	f(b)	f(c)	f(d)	Q(f; θ)
0	0	0	0	18
0	0	0	1	15
0	0	1	0	27
0	0	1	1	20
0	1	0	0	22
0	1	0	1	19
0	1	1	0	27
0	1	1	1	20

f(a)	f(b)	f(c)	f(d)	Q(f; θ)
1	0	0	0	16
1	0	0	1	13
1	0	1	0	25
1	0	1	1	18
1	1	0	0	18
1	1	0	1	15
1	1	1	0	23
1	1	1	1	16

Computational Complexity

Segmentation

$2^{|V|}$



$|V|$ = number of pixels ≈ 153600

Can we do better than brute-force?

MAP Estimation is NP-hard !!

MAP Inference / Energy Minimization

- Computing the assignment minimizing the energy in NP-hard in general

$$\operatorname{argmin}_{\mathbf{y} \in \mathcal{Y}} E(\mathbf{y}; \mathbf{x}) = \operatorname{argmax}_{\mathbf{y} \in \mathcal{Y}} P(\mathbf{y} | \mathbf{x})$$

- Exact inference is possible in some cases, e.g.,
 - Low treewidth graphs \rightarrow message-passing
 - Submodular potentials \rightarrow graph cuts
- Efficient approximate inference algorithms exist
 - Message passing on general graphs
 - Move-making algorithms
 - Relaxation algorithms

Overview

- Basics: problem formulation
 - Energy Function
 - MAP Estimation
 - Computing min-marginals
 - Reparameterization
- Solutions
 - Belief Propagation and related methods [Lecture 2]
 - Graph cuts [Lecture 3]

Min-Marginals

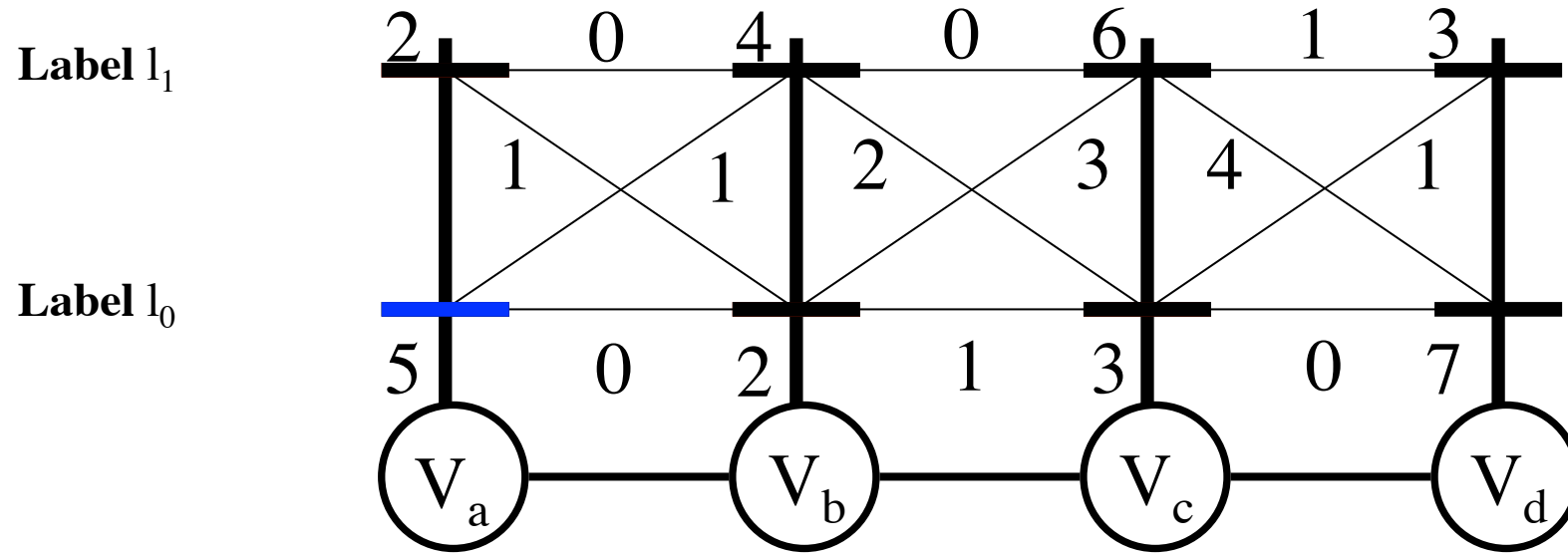

Not a marginal (no summation)

$f^* = \arg \min Q(f; \theta)$ such that $f(a) = i$

Min-marginal $q_{a,i}$

Min-Marginals

16 possible labellings

$$Q_{a;0} = 15$$

f(a)	f(b)	f(c)	f(d)	Q(f; θ)
0	0	0	0	18
0	0	0	1	15
0	0	1	0	27
0	0	1	1	20
0	1	0	0	22
0	1	0	1	19
0	1	1	0	27
0	1	1	1	20

f(a)	f(b)	f(c)	f(d)	Q(f; θ)
1	0	0	0	16
1	0	0	1	13
1	0	1	0	25
1	0	1	1	18
1	1	0	0	18
1	1	0	1	15
1	1	1	0	23
1	1	1	1	16

Min-Marginals

16 possible labellings

$$Q_{a;1} = 13$$

f(a)	f(b)	f(c)	f(d)	Q(f; θ)
0	0	0	0	18
0	0	0	1	15
0	0	1	0	27
0	0	1	1	20
0	1	0	0	22
0	1	0	1	19
0	1	1	0	27
0	1	1	1	20

f(a)	f(b)	f(c)	f(d)	Q(f; θ)
1	0	0	0	16
1	0	0	1	13
1	0	1	0	25
1	0	1	1	18
1	1	0	0	18
1	1	0	1	15
1	1	1	0	23
1	1	1	1	16

Min-Marginals and MAP

- Minimum min-marginal of any variable = energy of MAP labelling

$$\min_i q_{a;i}$$

$$\min_i (\min_f Q(f; \theta) \text{ such that } f(a) = i)$$

V_a has to take one label

$$\min_f Q(f; \theta)$$

Summary

Energy Function

$$Q(\mathbf{f}; \theta) = \sum_a \theta_{a;f(a)} + \sum_{(a,b)} \theta_{ab;f(a)f(b)}$$

MAP Estimation

$$\mathbf{f}^* = \arg \min Q(\mathbf{f}; \theta)$$

Min-marginals

$$q_{a;i} = \min Q(\mathbf{f}; \theta) \quad \text{s.t. } f(a) = i$$

Overview

- Basics: problem formulation
 - Energy Function
 - MAP Estimation
 - Computing min-marginals
 - Reparameterization
- Solutions
 - Belief Propagation and related methods [Lecture 2]
 - Graph cuts [Lecture 3]

Reparameterization

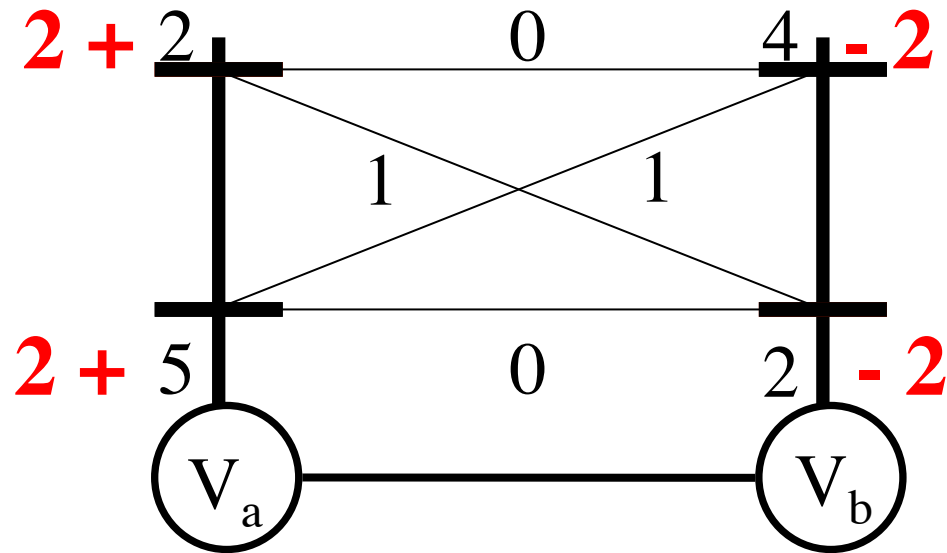

f(a)	f(b)	Q(f; θ)
0	0	7 + 2 - 2
0	1	10 + 2 - 2
1	0	5 + 2 - 2
1	1	6 + 2 - 2

Add a constant to all $\theta_{a;i}$

Subtract that constant from all $\theta_{b;k}$

$$Q(f; \theta') = Q(f; \theta)$$

Reparameterization

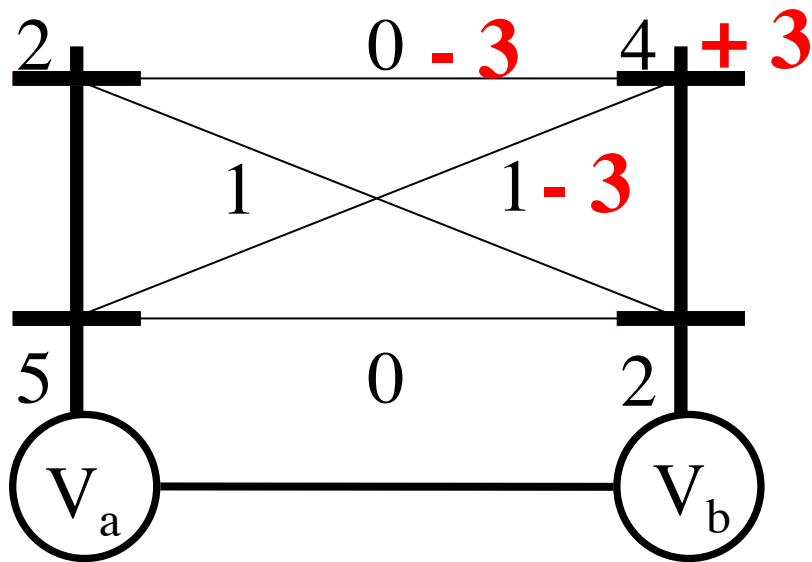

f(a)	f(b)	Q(f; θ)
0	0	7
0	1	10 - 3 + 3
1	0	5
1	1	6 - 3 + 3

Add a constant to one $\theta_{b;k}$

Subtract that constant from $\theta_{ab;ik}$ for all 'i'

$$Q(f; \theta') = Q(f; \theta)$$

Reparameterization

θ' is a reparameterization of θ , iff

$$Q(f; \theta') = Q(f; \theta), \text{ for all } f \quad \theta' \equiv \theta$$

Equivalently

$$\theta'_{a;i} = \theta_{a;i} + M_{ba;i}$$

$$\theta'_{b;k} = \theta_{b;k} + M_{ab;k}$$

$$\theta'_{ab;ik} = \theta_{ab;ik} - M_{ab;k} - M_{ba;i}$$

Kolmogorov, PAMI, 2006

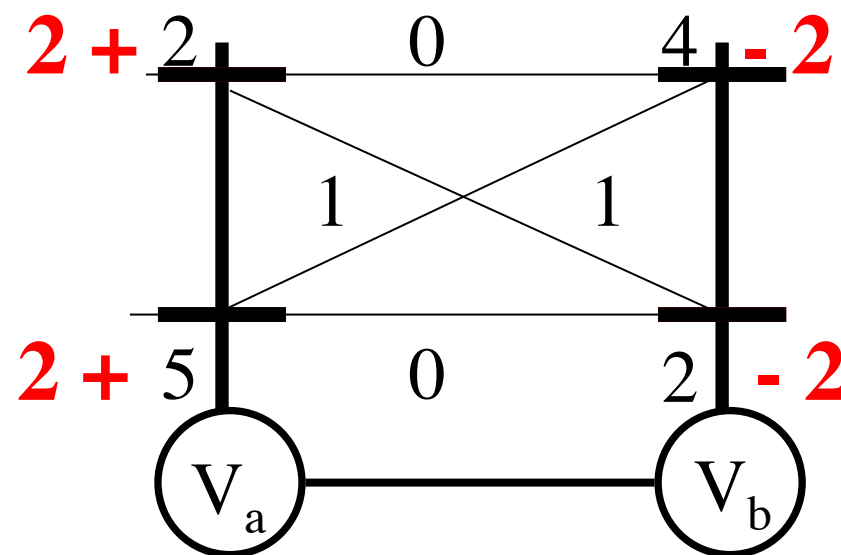

Recap

MAP Estimation

$$\mathbf{f}^* = \arg \min \mathbf{Q}(\mathbf{f}; \boldsymbol{\theta})$$

$$\mathbf{Q}(\mathbf{f}; \boldsymbol{\theta}) = \sum_a \theta_{a;f(a)} + \sum_{(a,b)} \theta_{ab;f(a)f(b)}$$

Min-marginals

$$q_{a;i} = \min \mathbf{Q}(\mathbf{f}; \boldsymbol{\theta}) \quad \text{s.t. } f(a) = i$$

Reparameterization

$$\mathbf{Q}(\mathbf{f}; \boldsymbol{\theta}') = \mathbf{Q}(\mathbf{f}; \boldsymbol{\theta}), \text{ for all } \mathbf{f} \quad \boldsymbol{\theta}' \equiv \boldsymbol{\theta}$$

Overview

- Basics: problem formulation
 - Energy Function
 - MAP Estimation
 - Computing min-marginals
 - Reparameterization
- Solutions
 - Belief Propagation and related methods [Lecture 2]
 - Graph cuts [Lecture 3]

Belief Propagation

- Remember, some MAP problems are easy
- Belief Propagation gives exact MAP for chains
- Exact MAP for trees
- Clever Reparameterization

Two Variables

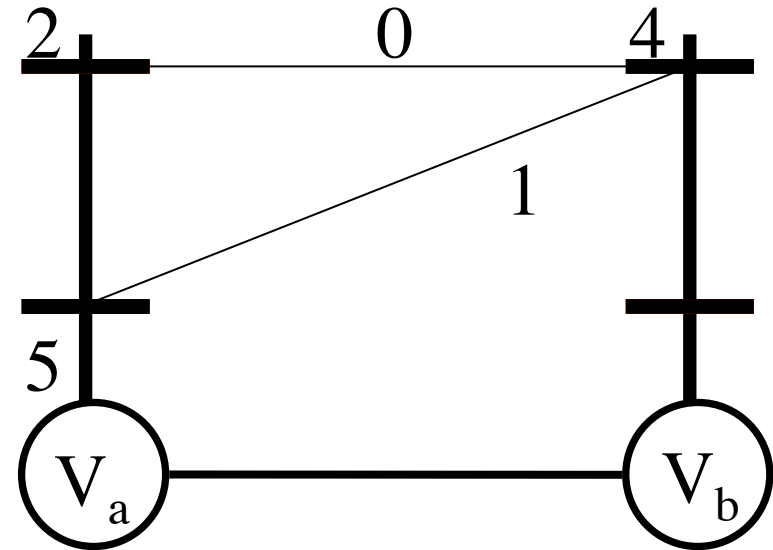
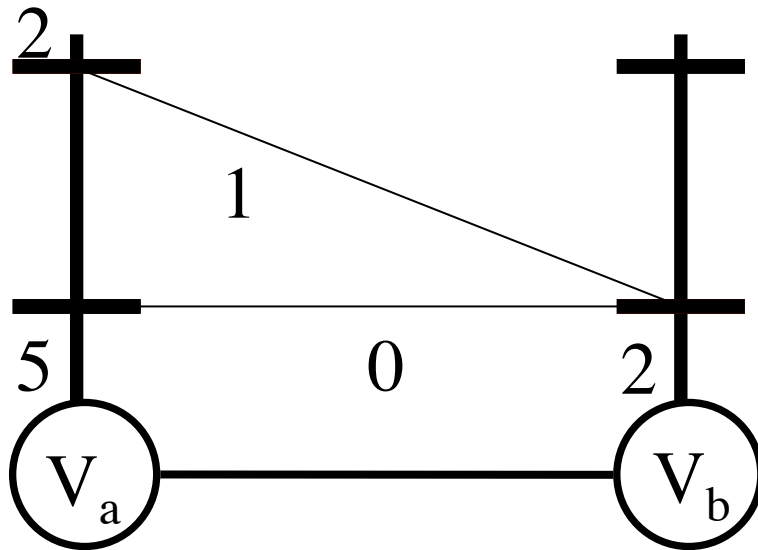

Add a constant to one $\theta_{b;k}$

Subtract that constant from $\theta_{ab;ik}$ for all 'i'

Choose the *right* constant $\theta'_{b;k} = q_{b;k}$

Two Variables

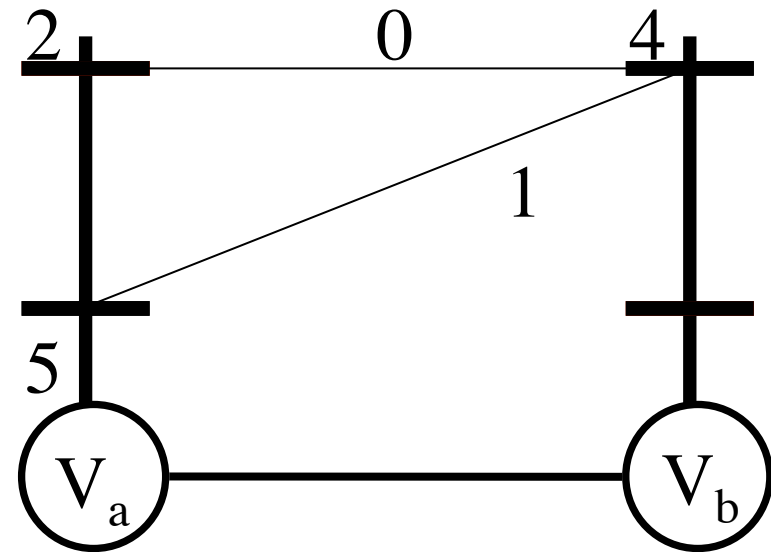
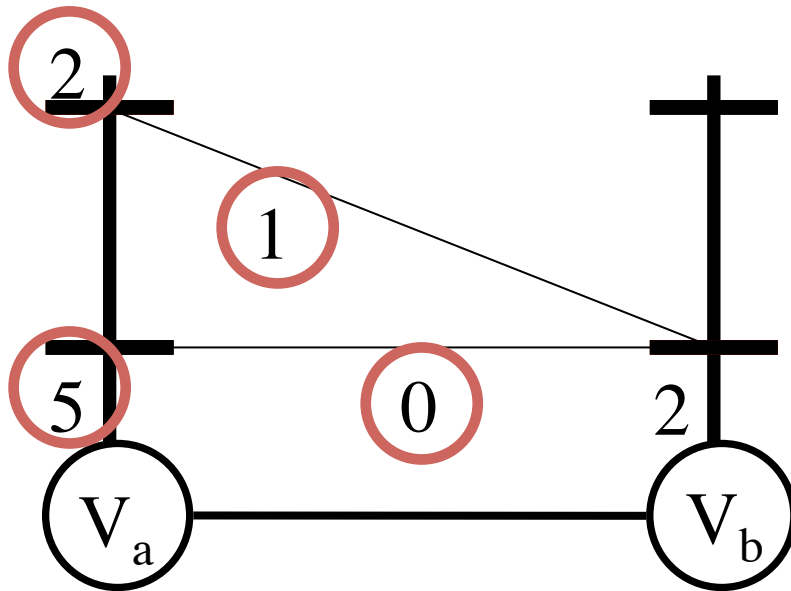

$$M_{ab;0} = \min \begin{cases} \theta_{a;0} + \theta_{ab;00} = 5 + 0 \\ \theta_{a;1} + \theta_{ab;10} = 2 + 1 \end{cases}$$

Choose the *right* constant $\theta'_{b;k} = q_{b;k}$

Two Variables

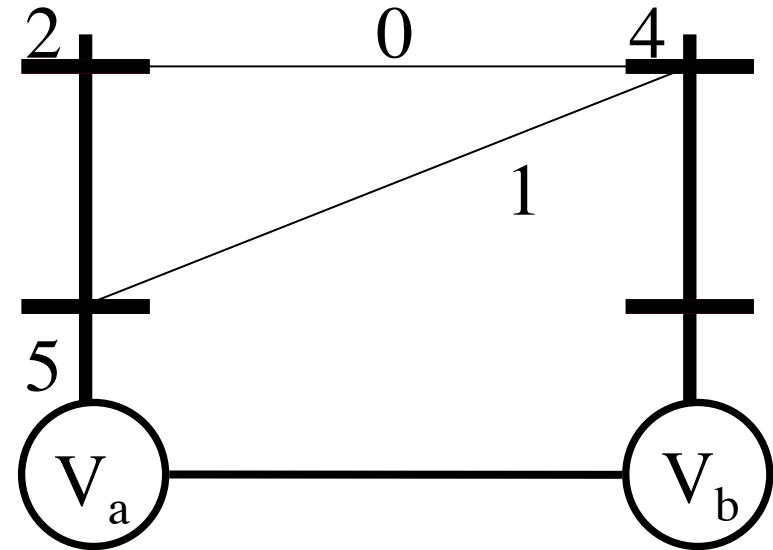
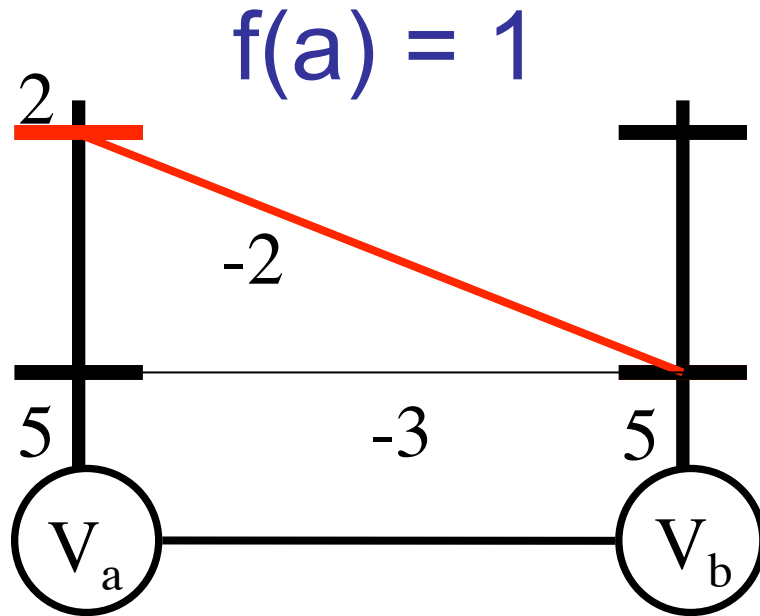

$$\theta'_{b;0} = q_{b;0}$$

Potentials along the red path add up to 0

Choose the **right** constant $\theta'_{b;k} = q_{b;k}$

Two Variables

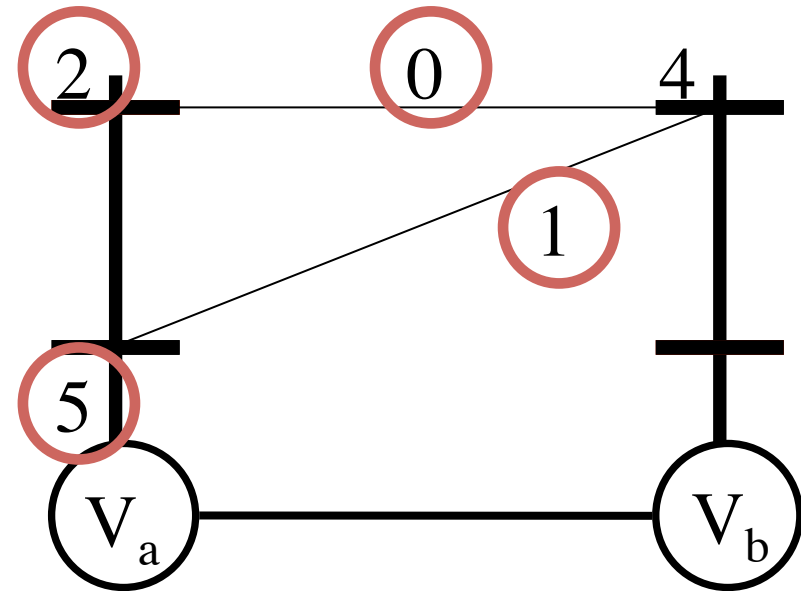
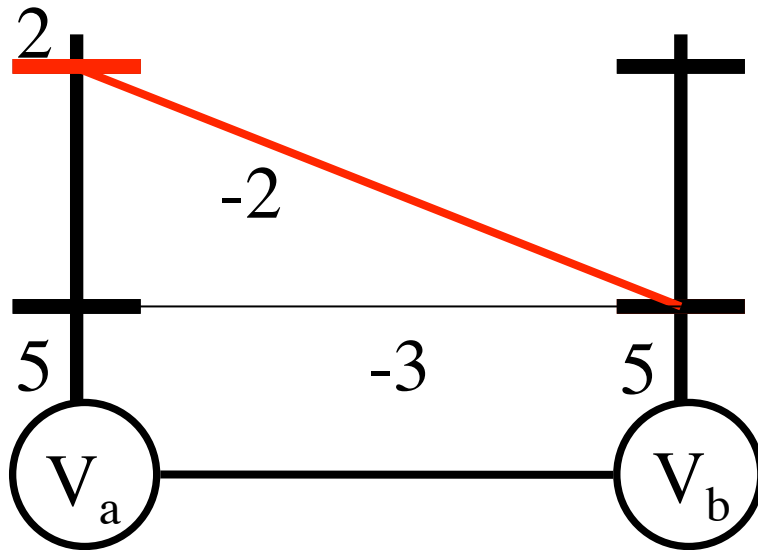

$$M_{ab;1} = \min \begin{cases} \theta_{a;0} + \theta_{ab;01} = 5 + 1 \\ \theta_{a;1} + \theta_{ab;11} = 2 + 0 \end{cases}$$

Choose the *right* constant $\theta'_{b;k} = q_{b;k}$

Two Variables

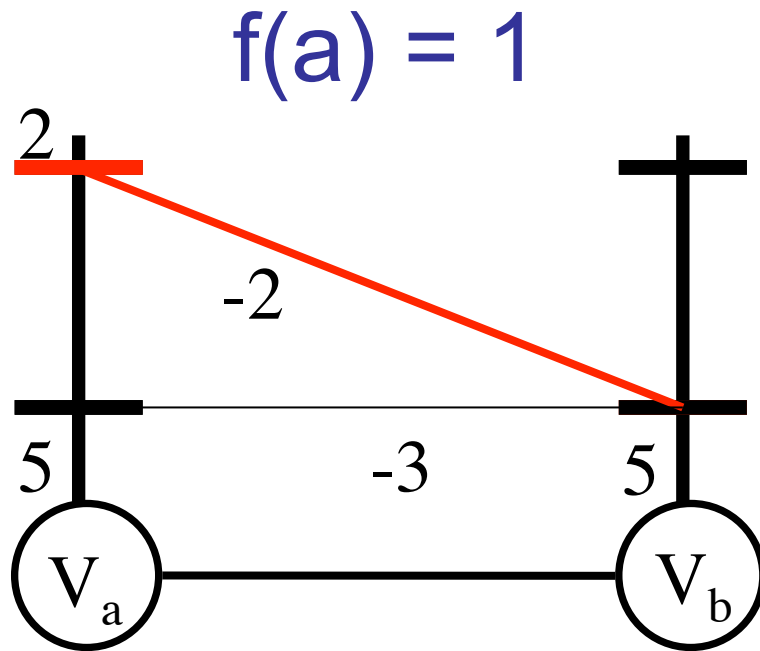

$$\theta'_{b;0} = q_{b;0}$$

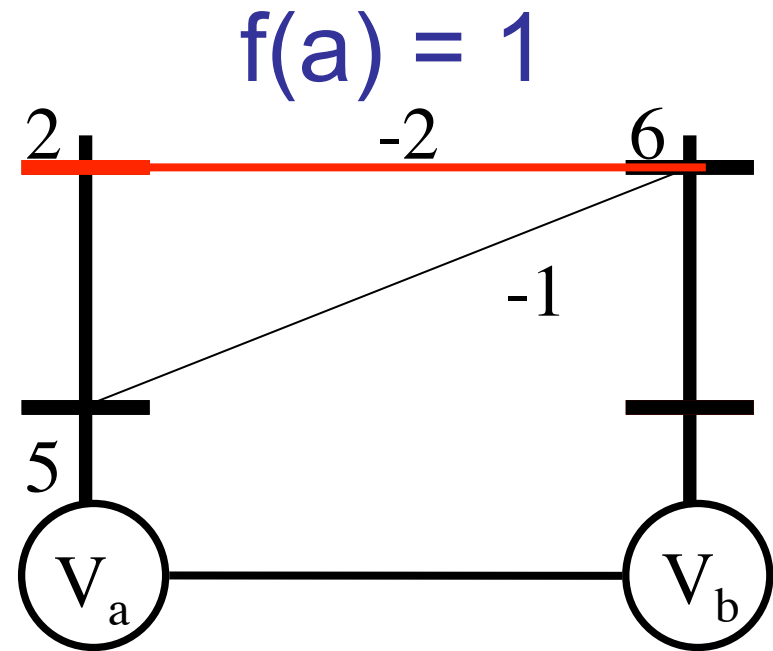

$$\theta'_{b;1} = q_{b;1}$$

Minimum of min-marginals = MAP estimate

Choose the *right* constant $\theta'_{b;k} = q_{b;k}$

Two Variables

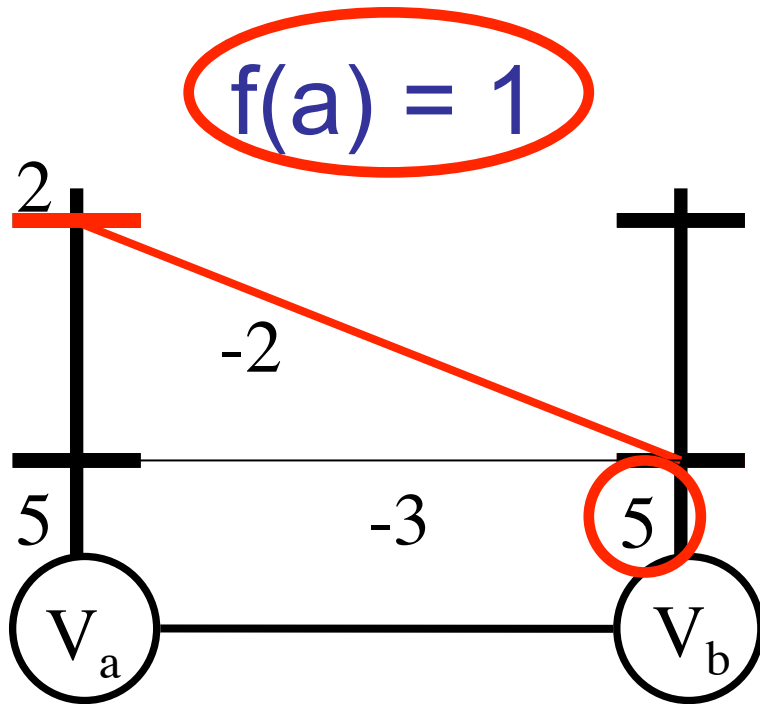

$$\theta'_{b;0} = q_{b;0}$$

$$f^*(b) = 0 \quad f^*(a) = 1$$

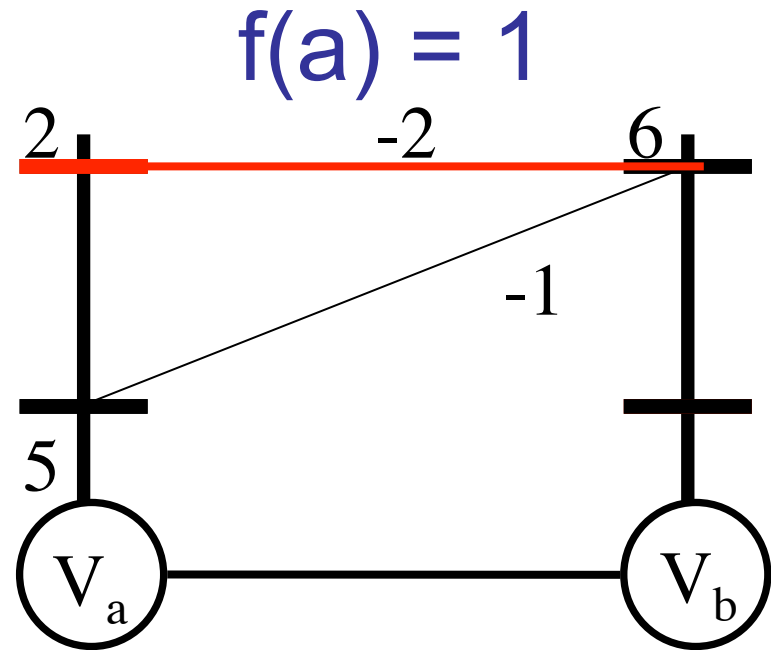

$$\theta'_{b;1} = q_{b;1}$$

Choose the **right** constant

$$\theta'_{b;k} = q_{b;k}$$

Two Variables

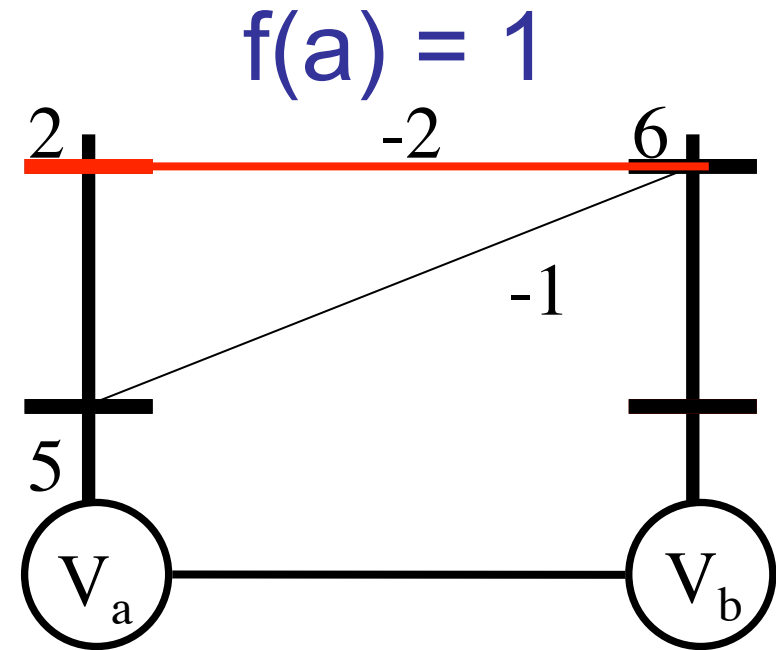
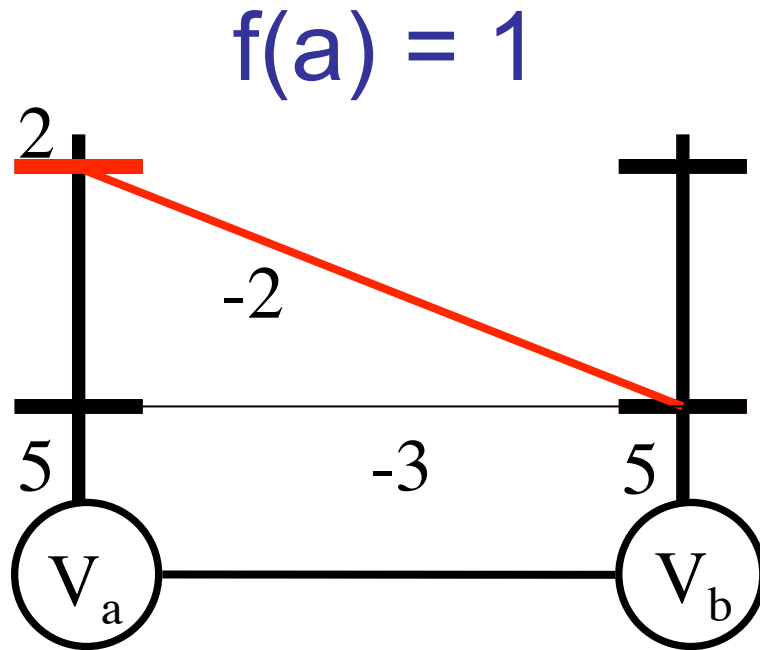

We get all the min-marginals of V_b

Choose the *right* constant $\theta'_{b;k} = q_{b;k}$

Recap

We only need to know two sets of equations

General form of Reparameterization

$$\theta'_{a;i} = \theta_{a;i} + M_{ba;i} \quad \theta'_{b;k} = \theta_{b;k} + M_{ab;k}$$

$$\theta'_{ab;ik} = \theta_{ab;ik} - M_{ab;k} - M_{ba;i}$$

Reparameterization of (a,b) in Belief Propagation

$$M_{ab;k} = \min_i \{ \theta_{a;i} + \theta_{ab;ik} \}$$

$$M_{ba;i} = 0$$

Three Variables

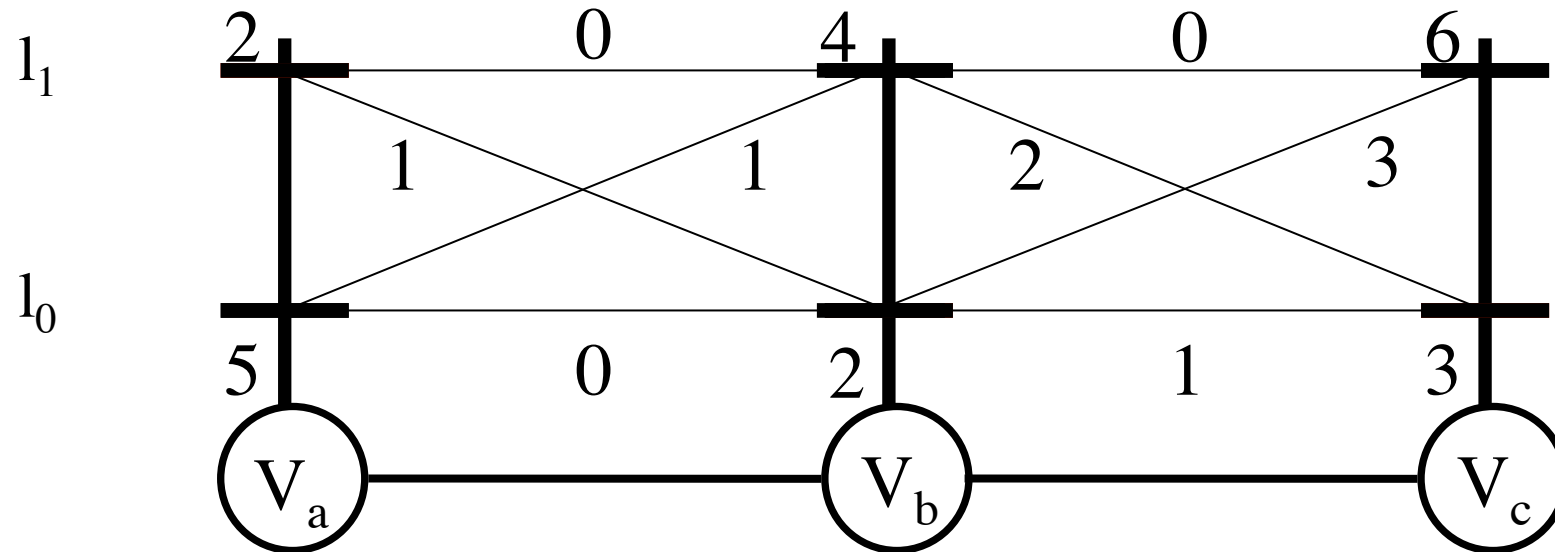

Reparameterize the edge (a,b) as before

Three Variables

$$f(a) = 1$$

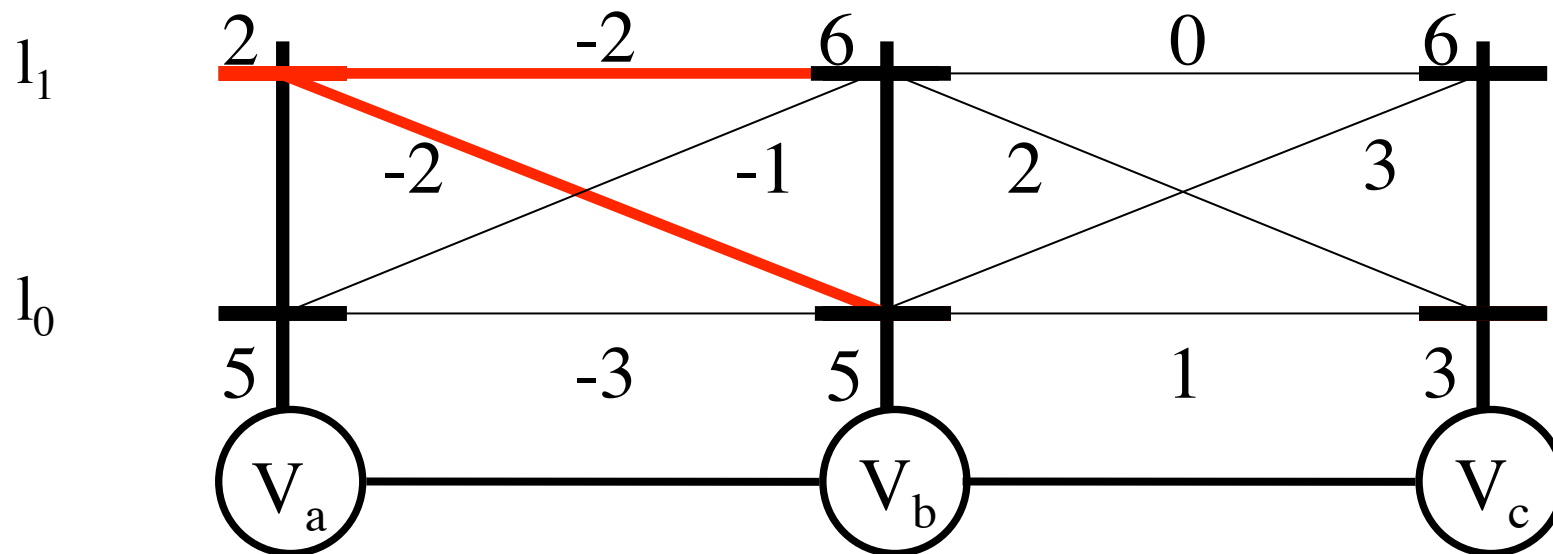

$$f(a) = 1$$

Reparameterize the edge (a,b) as before

Potentials along the red path add up to 0

Three Variables

$$f(a) = 1$$

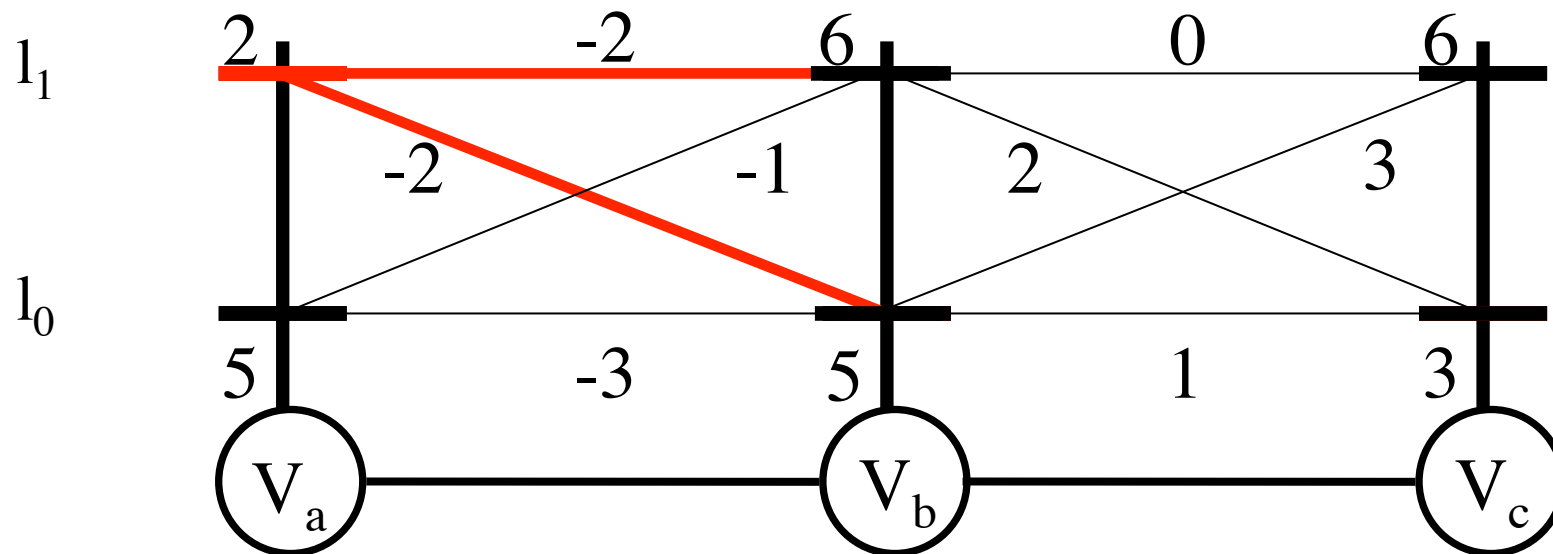

$$f(a) = 1$$

Reparameterize the edge (b,c) as before

Potentials along the red path add up to 0

Three Variables

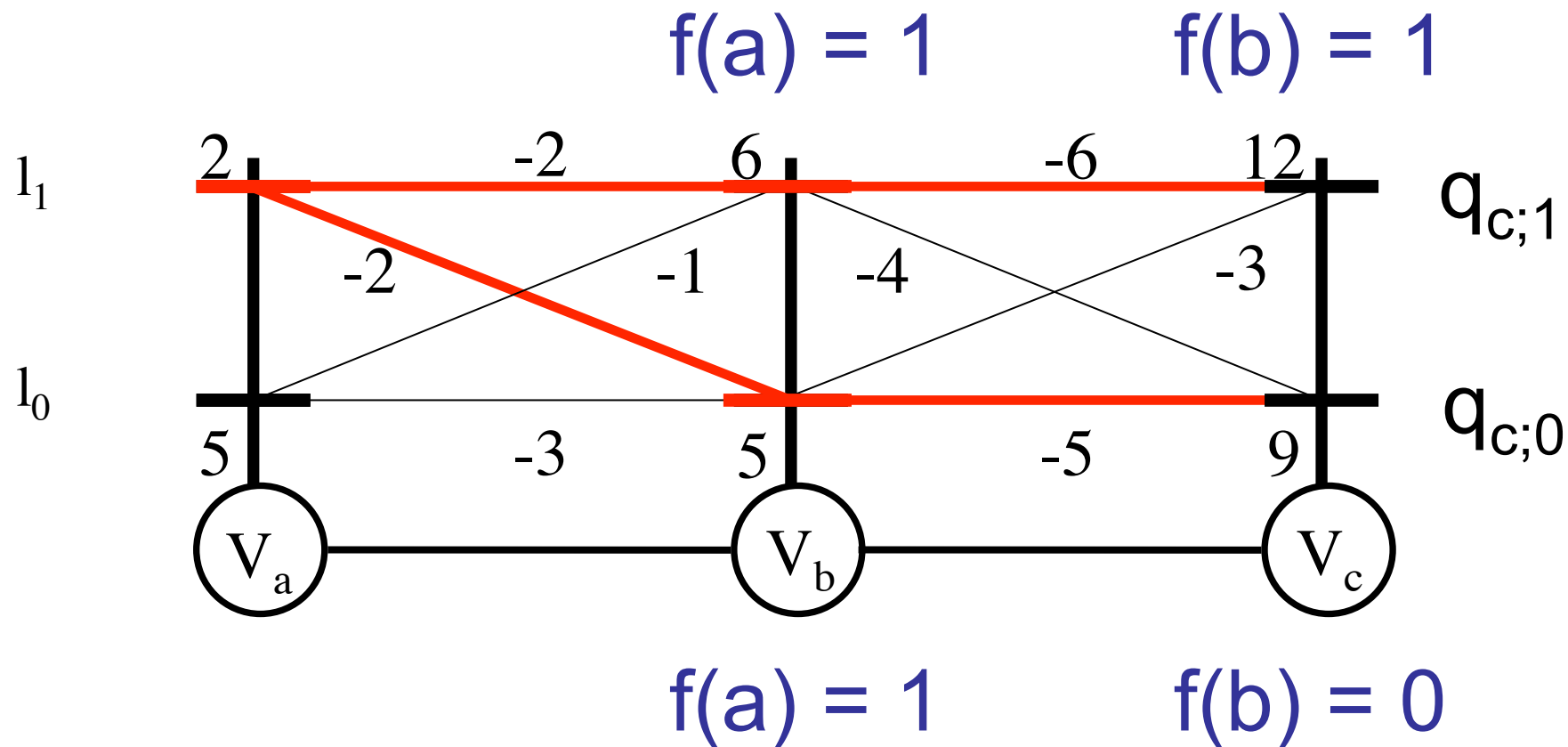

Reparameterize the edge (b,c) as before

Potentials along the red path add up to 0

Three Variables

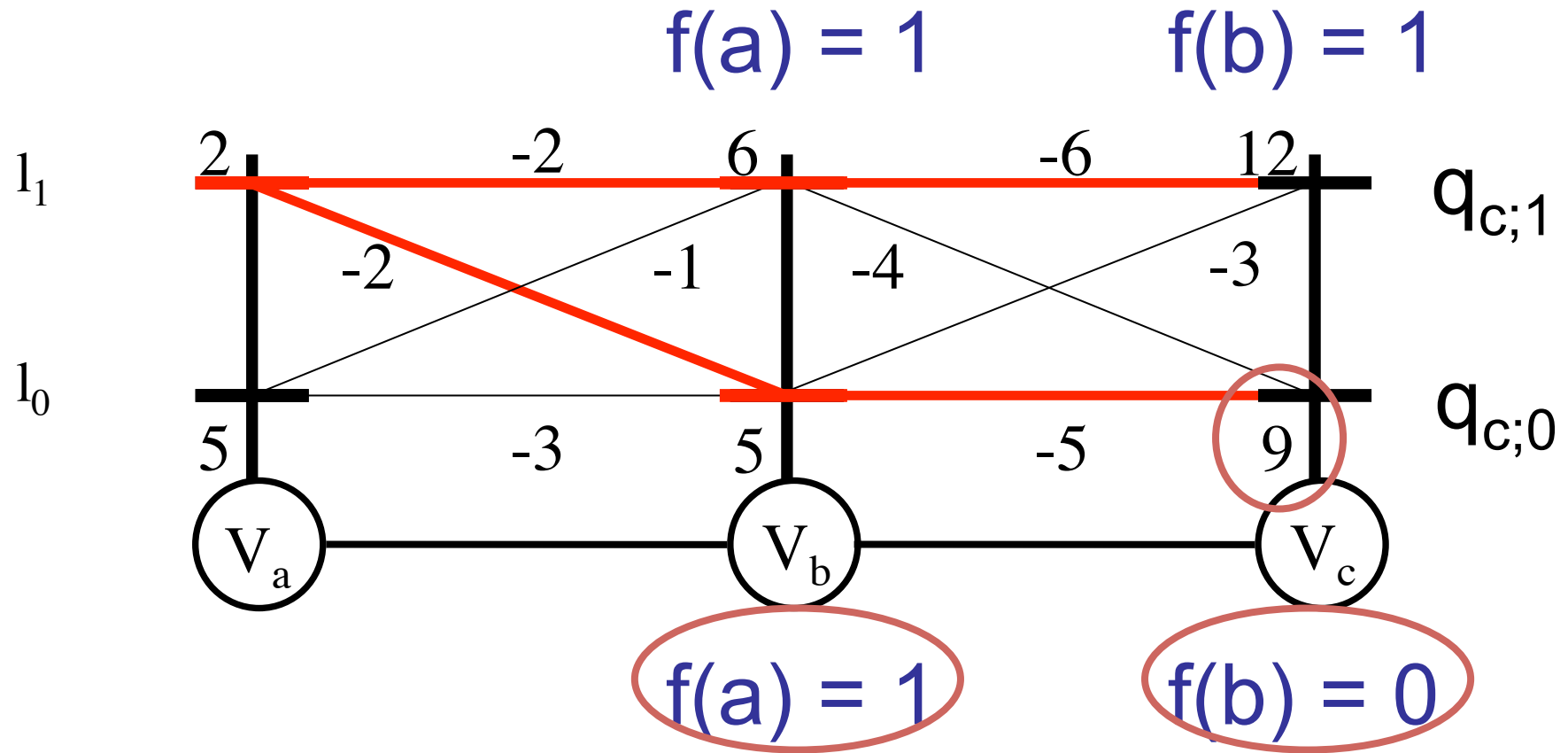

$$f^*(c) = 0 \quad f^*(b) = 0 \quad f^*(a) = 1$$

Generalizes to any length chain

Three Variables

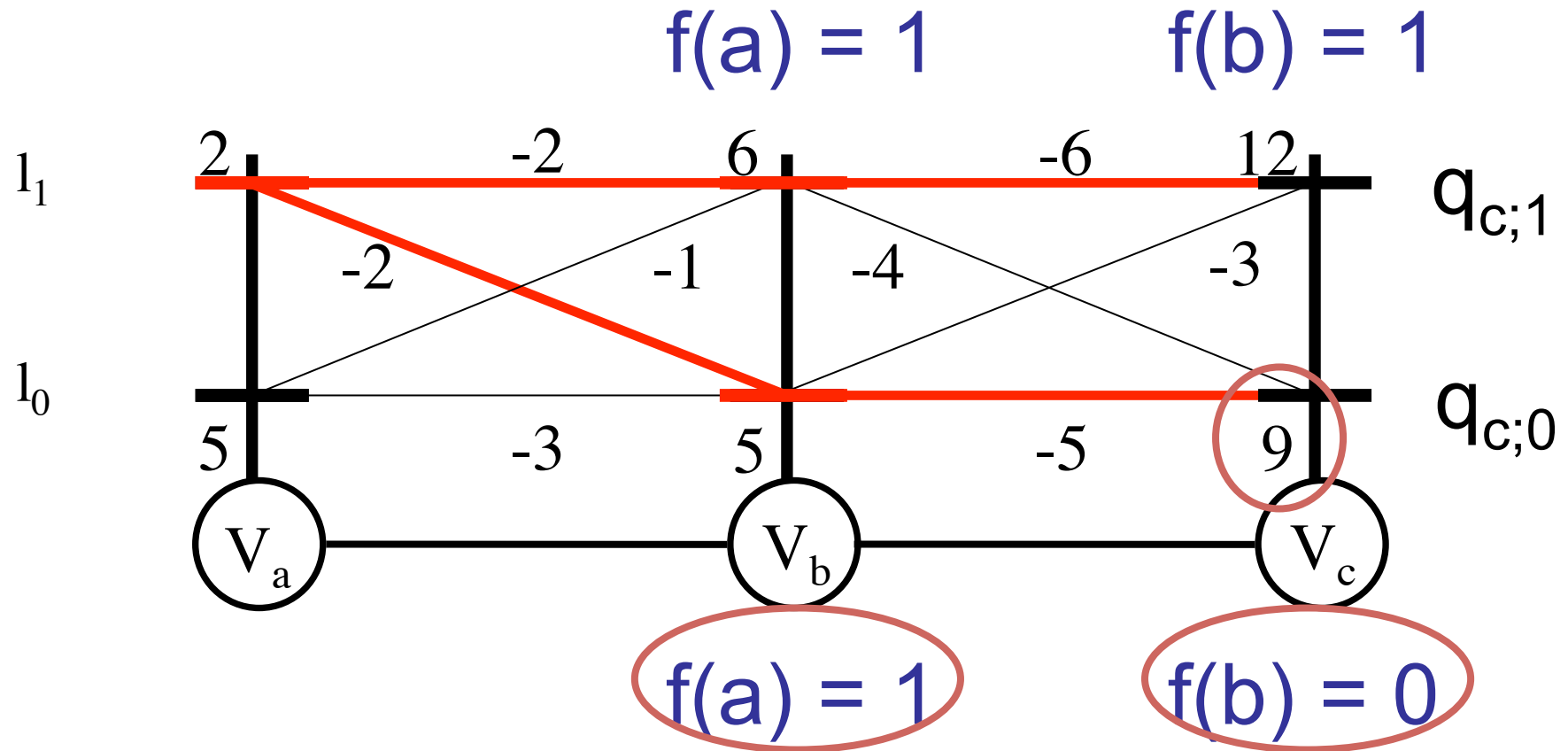

$$f^*(c) = 0 \quad f^*(b) = 0 \quad f^*(a) = 1$$

Only Dynamic Programming

Why Dynamic Programming?

3 variables \equiv 2 variables + book-keeping

n variables \equiv (n-1) variables + book-keeping

Start from left, go to right

Reparameterize current edge (a,b)

$$M_{ab;k} = \min_i \{ \theta_{a;i} + \theta_{ab;ik} \}$$

$$\theta'_{b;k} = \theta_{b;k} + M_{ab;k} \quad \theta'_{ab;ik} = \theta_{ab;ik} - M_{ab;k}$$

Repeat

Why Dynamic Programming?

Messages Message Passing

Why stop at dynamic programming?

Start from left, go to right

Reparameterize current edge (a,b)

$$M_{ab;k} = \min_i \{ \theta_{a;i} + \theta_{ab;ik} \}$$

$$\theta'_{b;k} = \theta_{b;k} + M_{ab;k} \quad \theta'_{ab;ik} = \theta_{ab;ik} - M_{ab;k}$$

Repeat

Three Variables

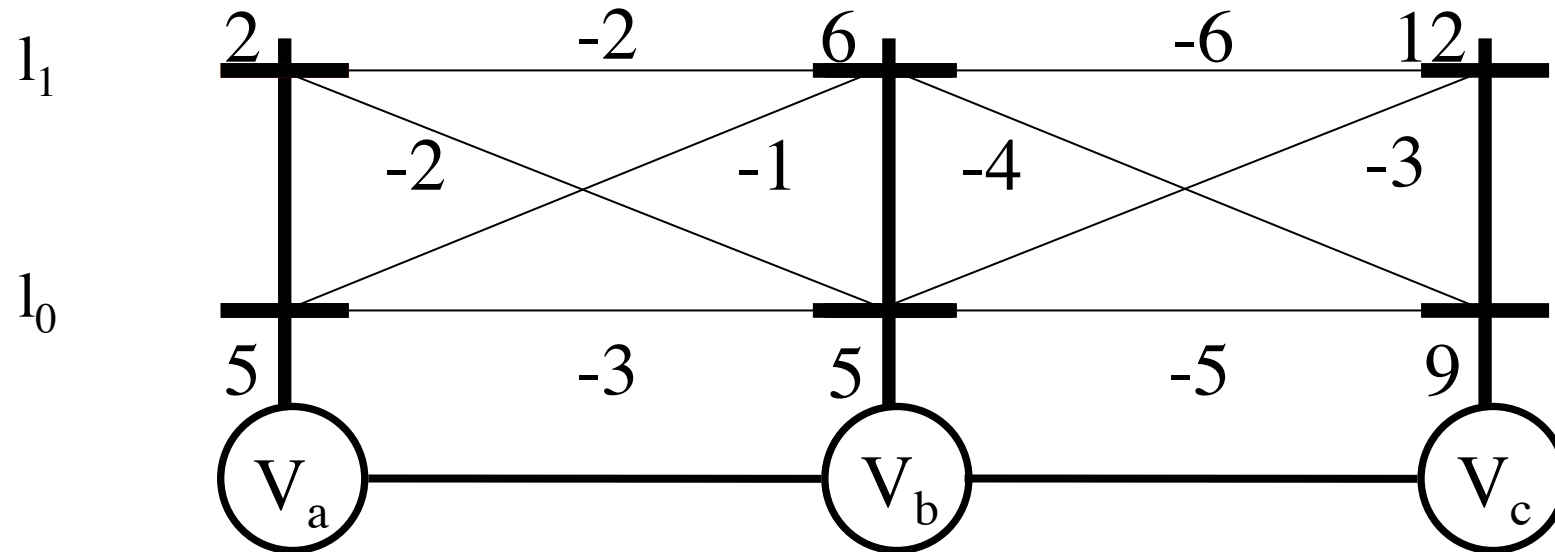

Reparameterize the edge (c,b) as before

Three Variables

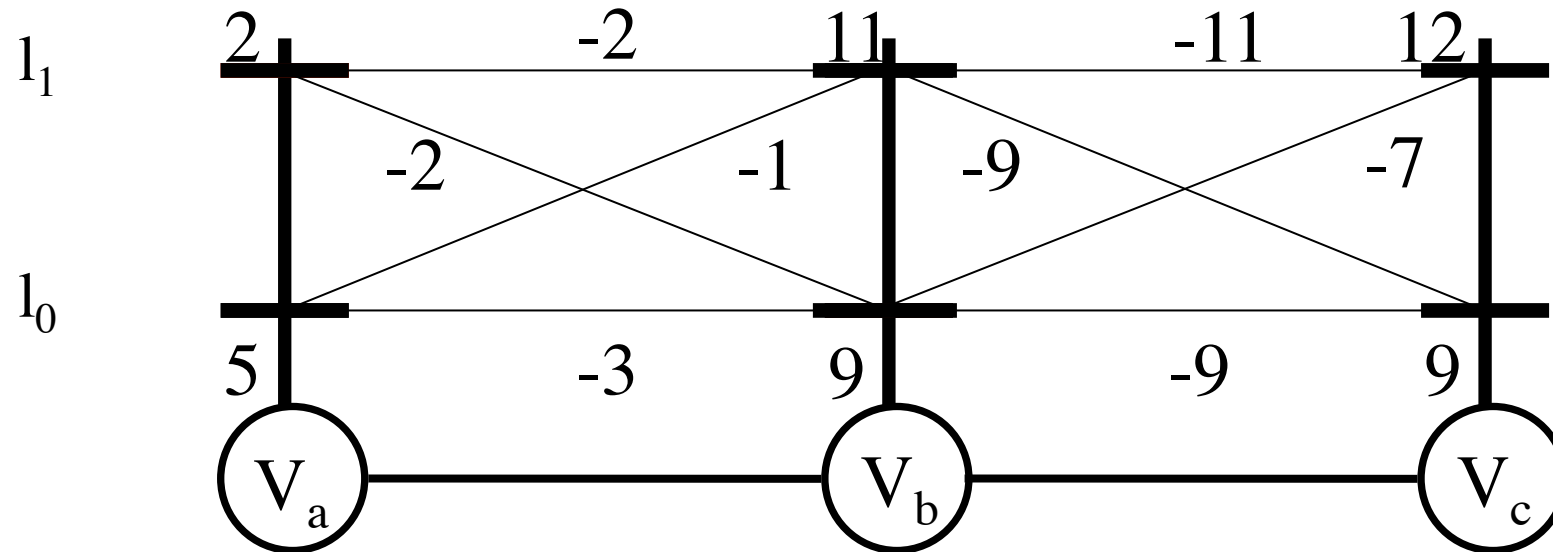

Reparameterize the edge (c,b) as before

$$\theta'_{b;i} = q_{b;i}$$

Three Variables

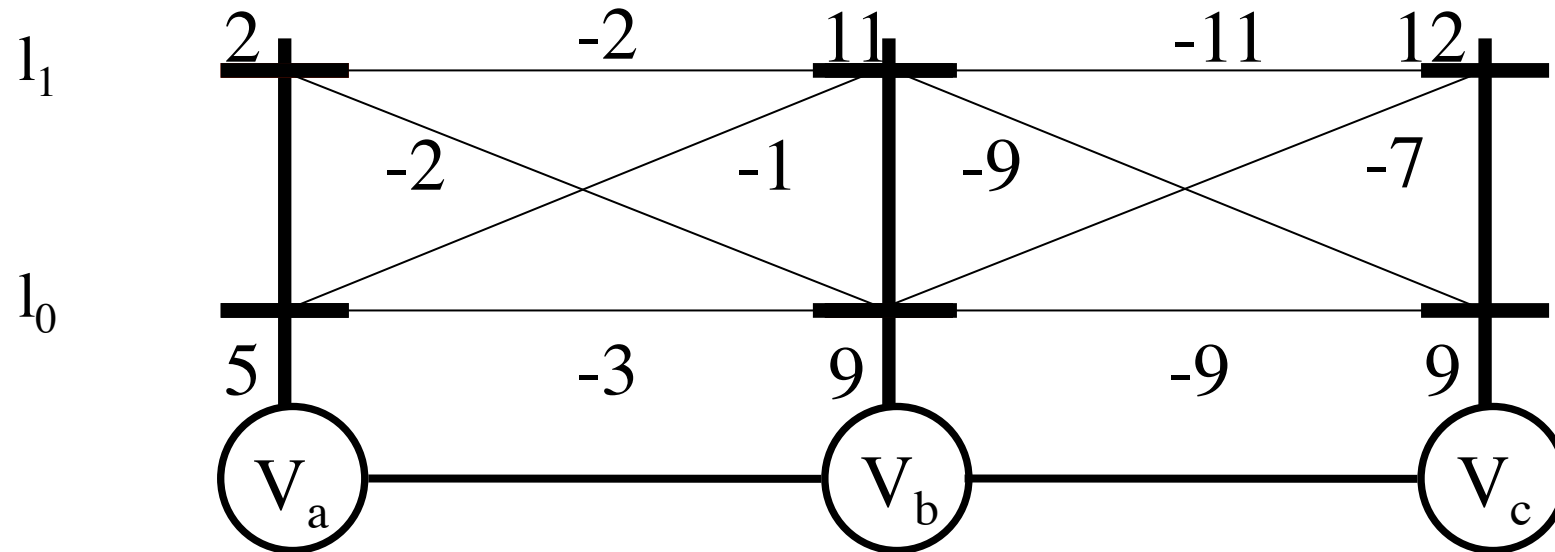

Reparameterize the edge (b,a) as before

Three Variables

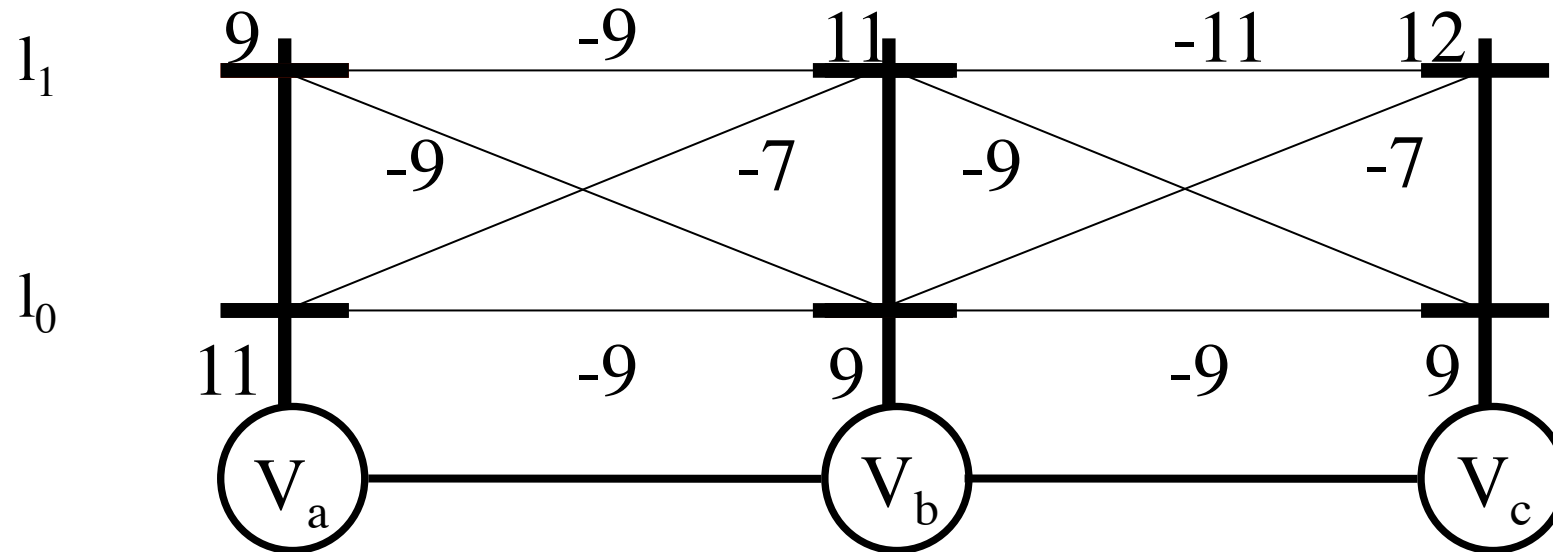

Reparameterize the edge (b,a) as before

$$\theta'_{a;i} = q_{a;i}$$

Three Variables

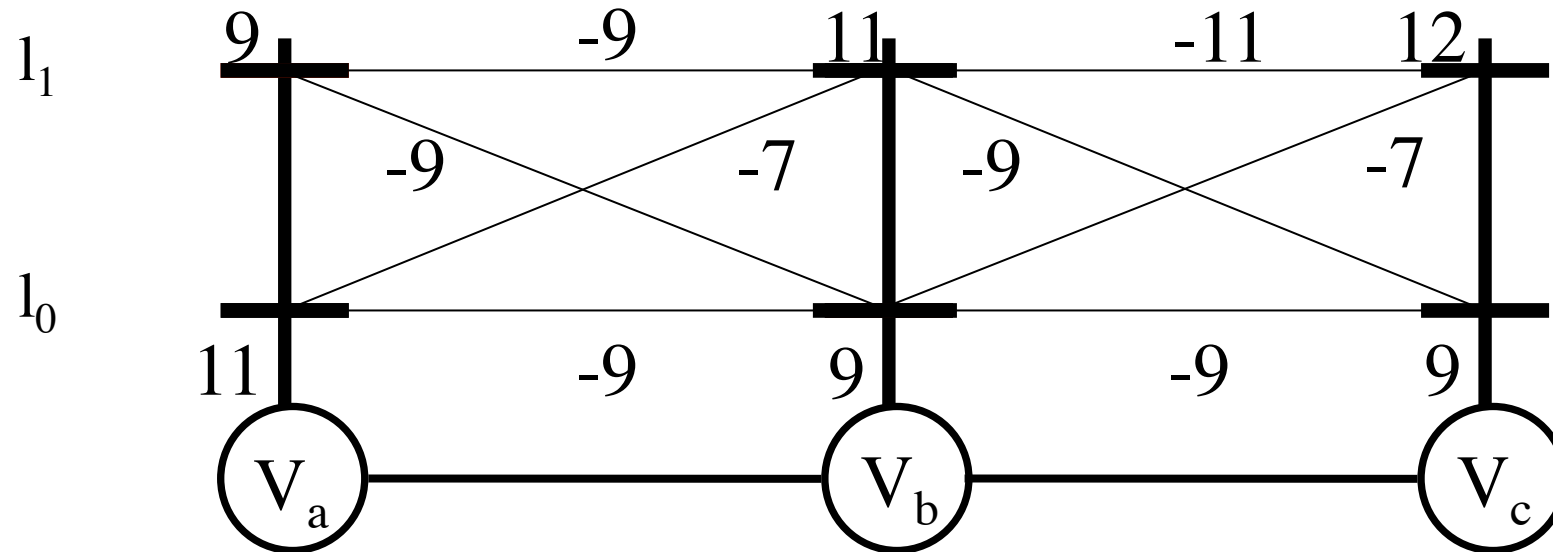

Forward Pass →

← Backward Pass

All min-marginals are computed

Chains



Reparameterize the edge (1,2)

Chains



Reparameterize the edge (1,2)

Chains



Reparameterize the edge (2,3)

Chains



Reparameterize the edge $(n-1, n)$

Min-marginals $e_n(i)$ for all labels

Belief Propagation on Chains

Start from left, go to right

Reparameterize current edge (a,b)

$$M_{ab;k} = \min_i \{ \theta_{a;i} + \theta_{ab;ik} \}$$

$$\theta'_{b;k} = \theta_{b;k} + M_{ab;k} \quad \theta'_{ab;ik} = \theta_{ab;ik} - M_{ab;k}$$

Repeat till the end of the chain

Start from right, go to left

Repeat till the end of the chain

Belief Propagation on Chains

- Generalizes to chains of any length
- A way of computing reparam constants
- Forward Pass - Start to End
 - MAP estimate
 - Min-marginals of final variable
- Backward Pass - End to start
 - All other min-marginals

Computational Complexity

Number of reparameterization constants = $(n-1)h$

Complexity for each constant = $O(h)$

Total complexity = $O(nh^2)$

Better than brute-force $O(h^n)$

Trees

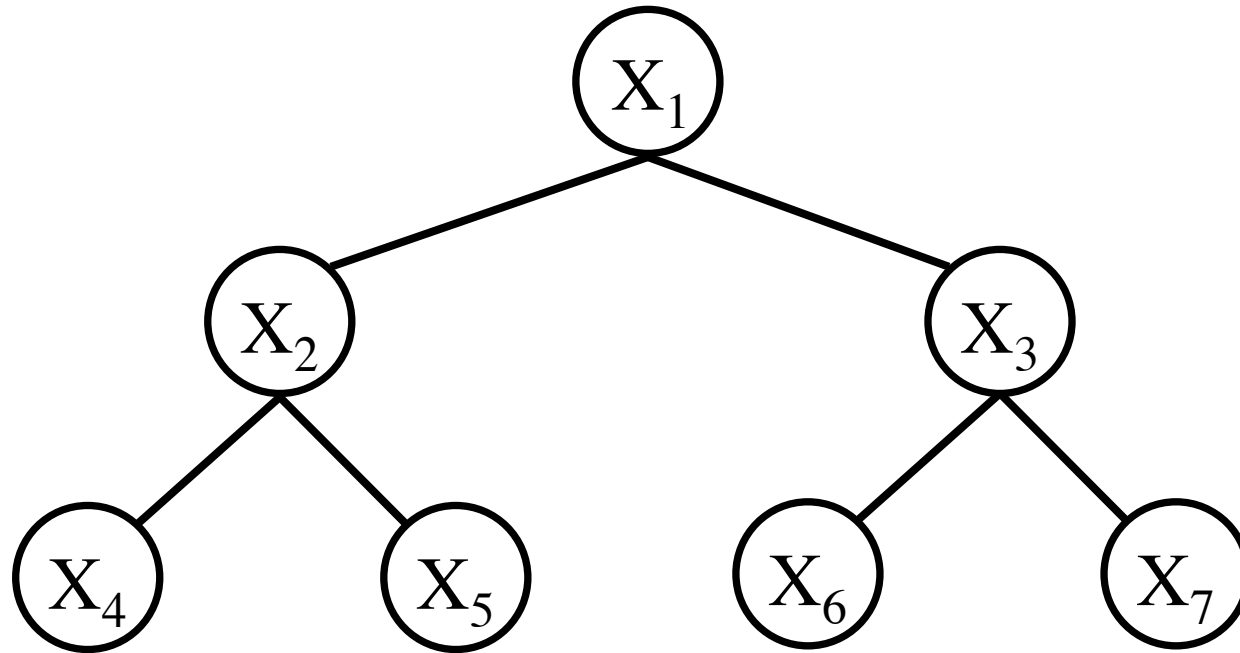

Reparameterize the edge (4,2)

Trees

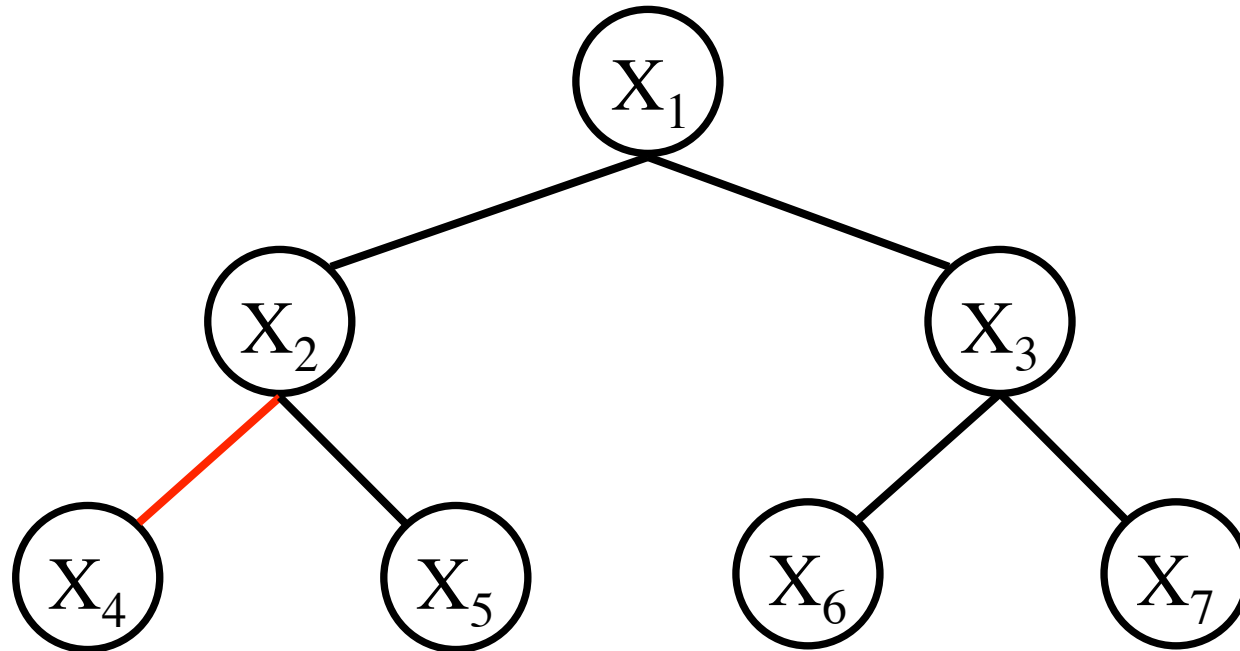

Reparameterize the edge (4,2)

Trees

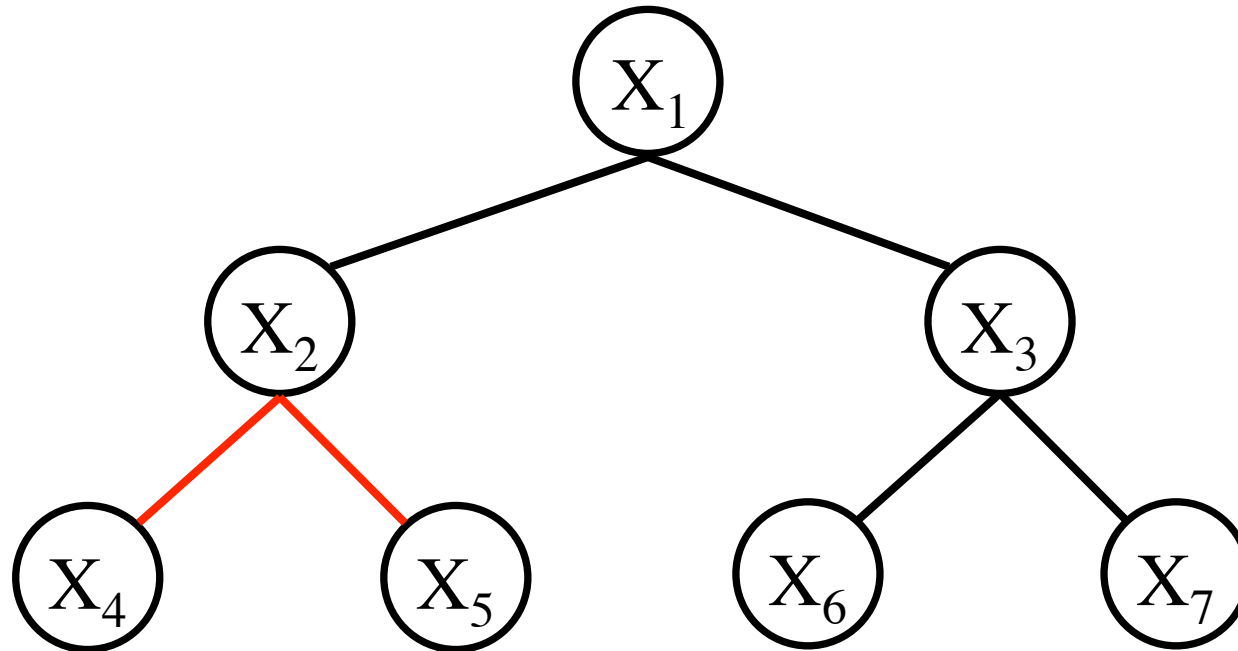

Reparameterize the edge (5,2)

Trees

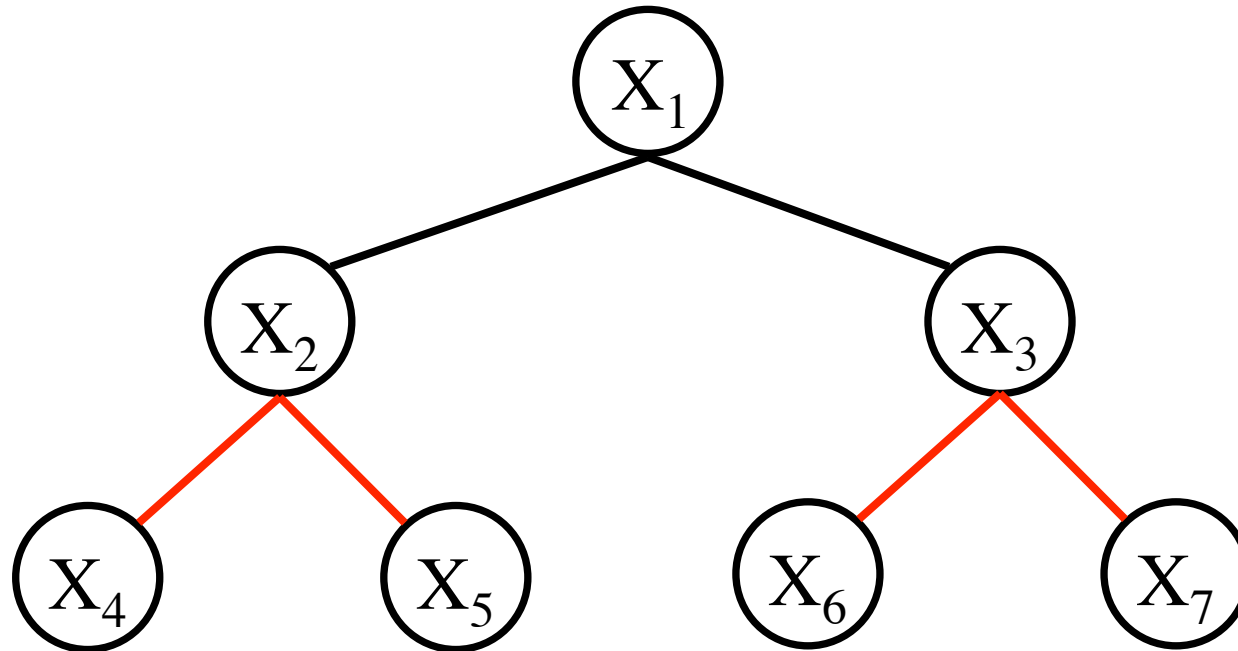

Reparameterize the edge (7,3)

Trees

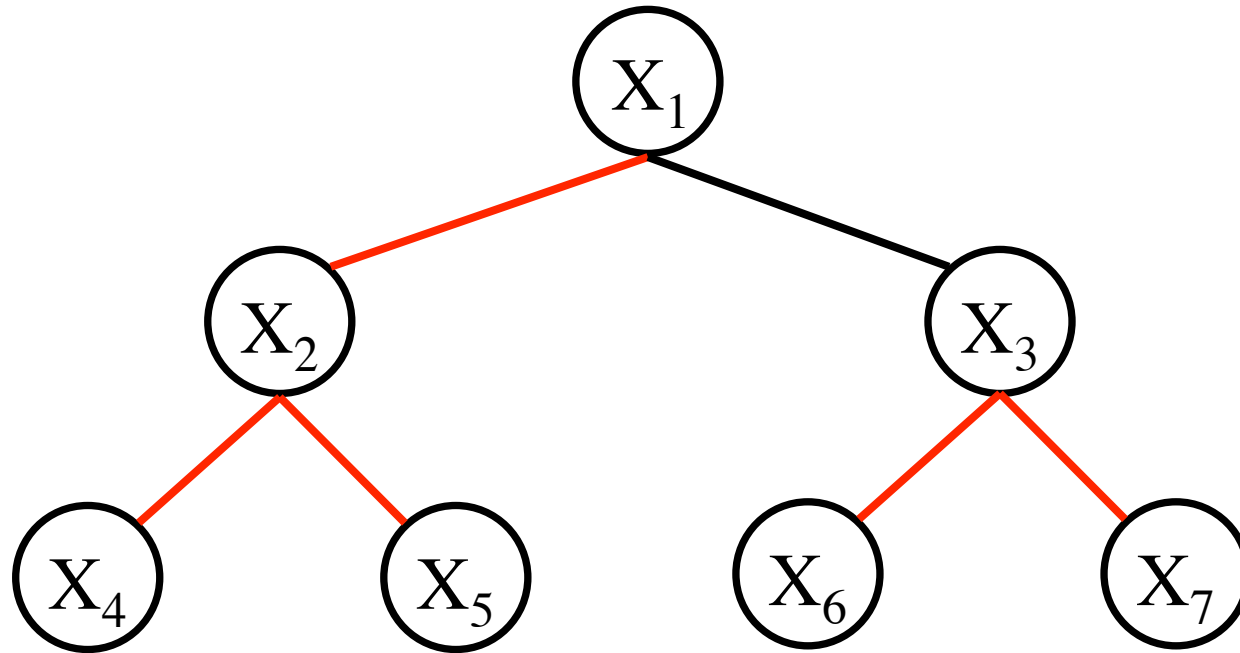

Reparameterize the edge (2,1)

Trees

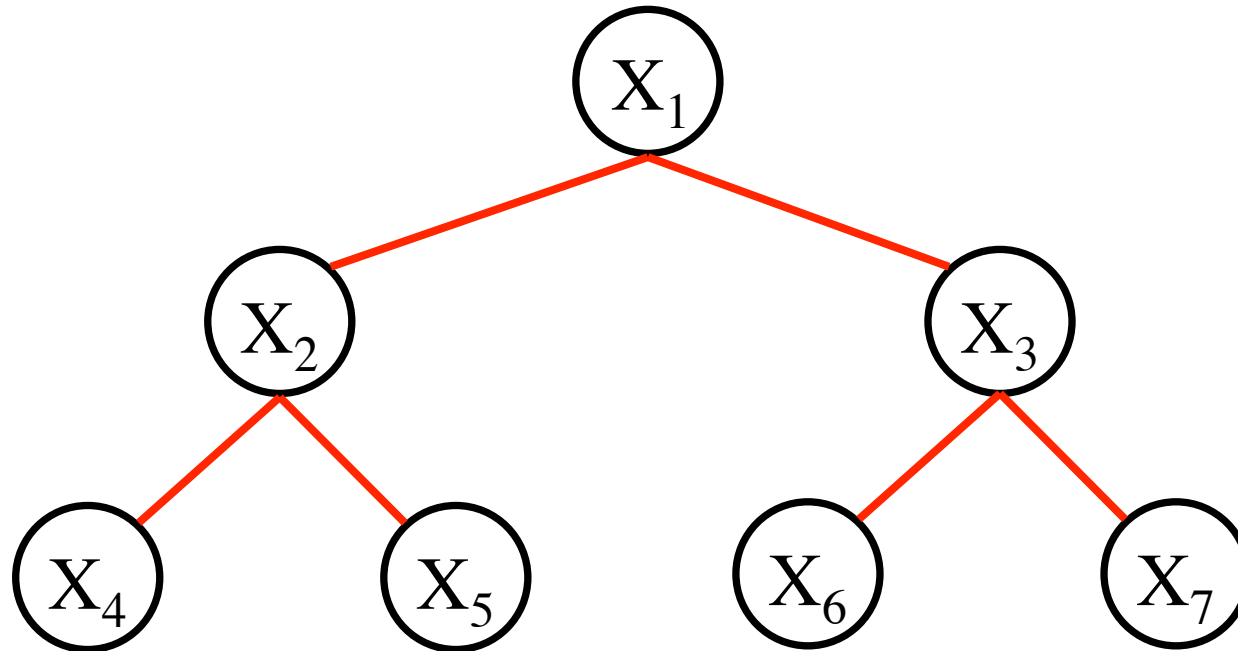

Reparameterize the edge $(3,1)$

Min-marginals $e_1(i)$ for all labels

Trees

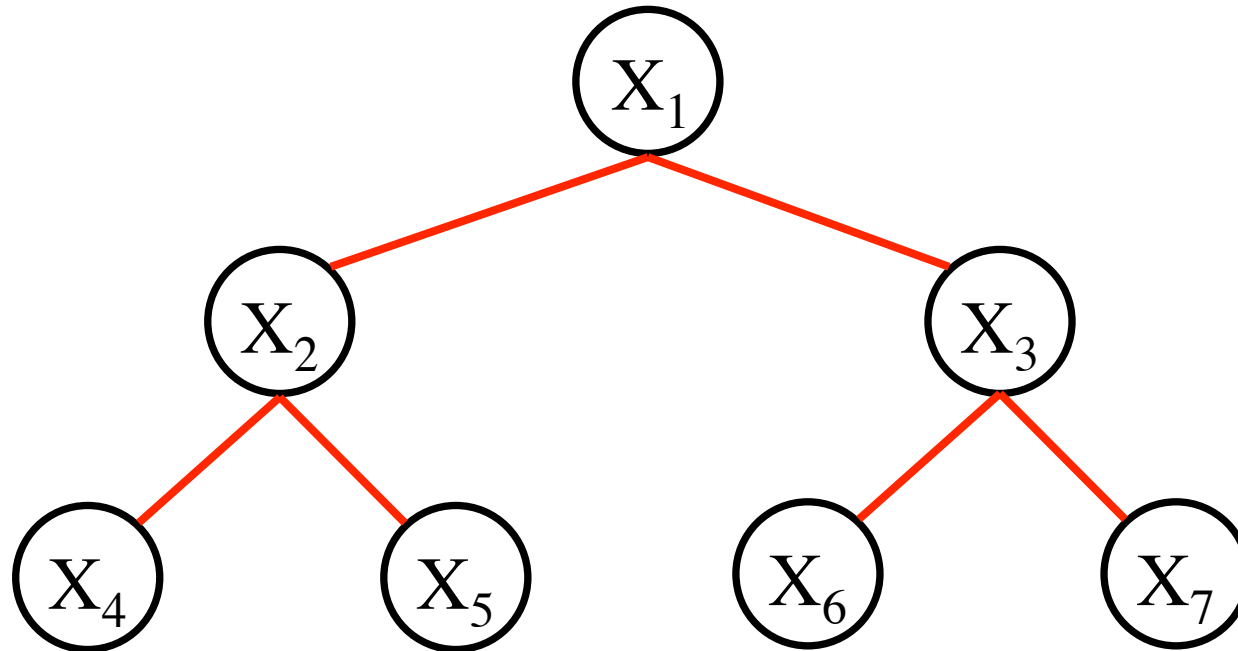

Start from leaves and move towards root

Pick the minimum of min-marginals

Backtrack to find the best labeling \mathbf{x}

Belief Propagation on Cycles

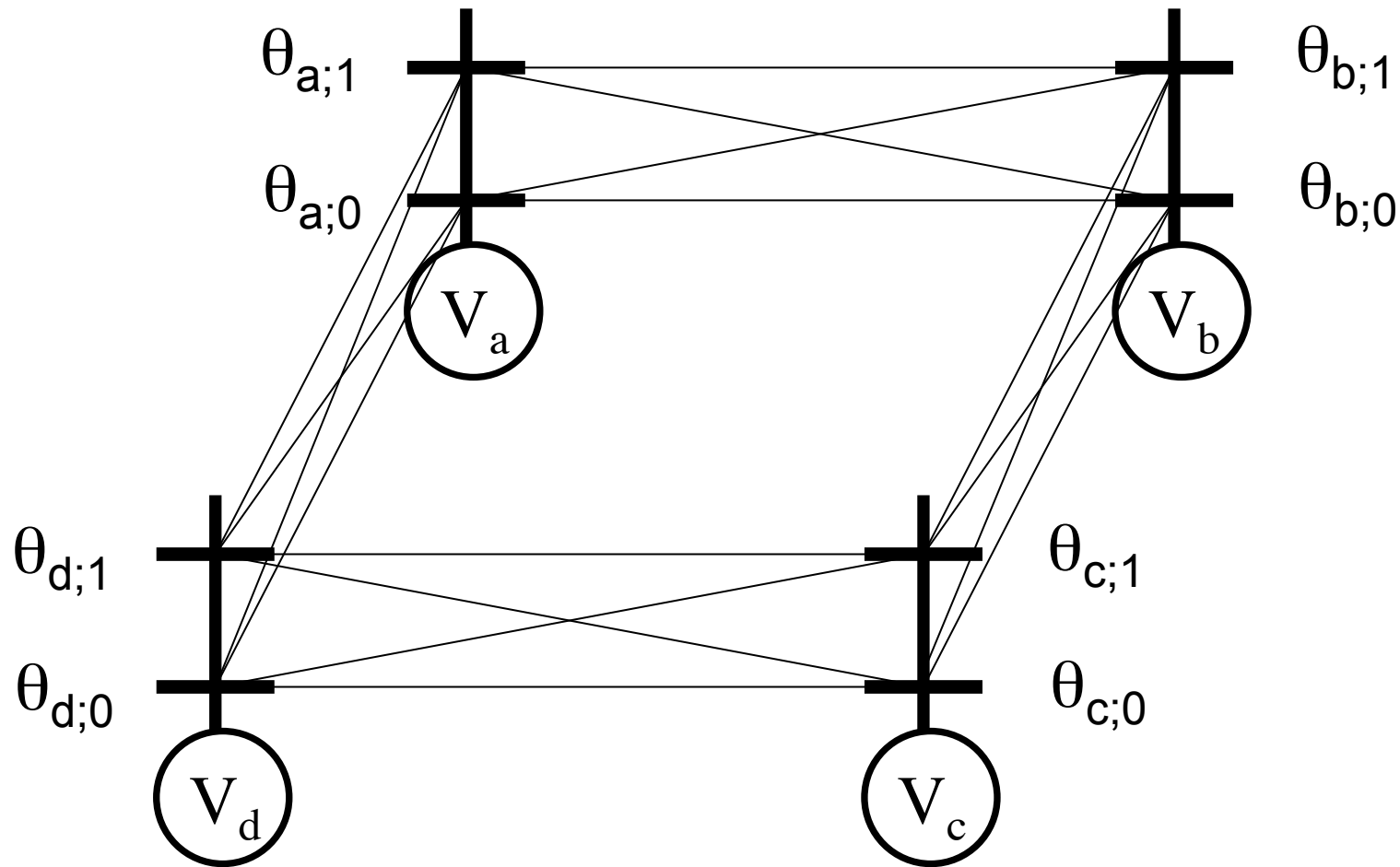

Where do we start?

Arbitrarily

Reparameterize (a,b)

Belief Propagation on Cycles

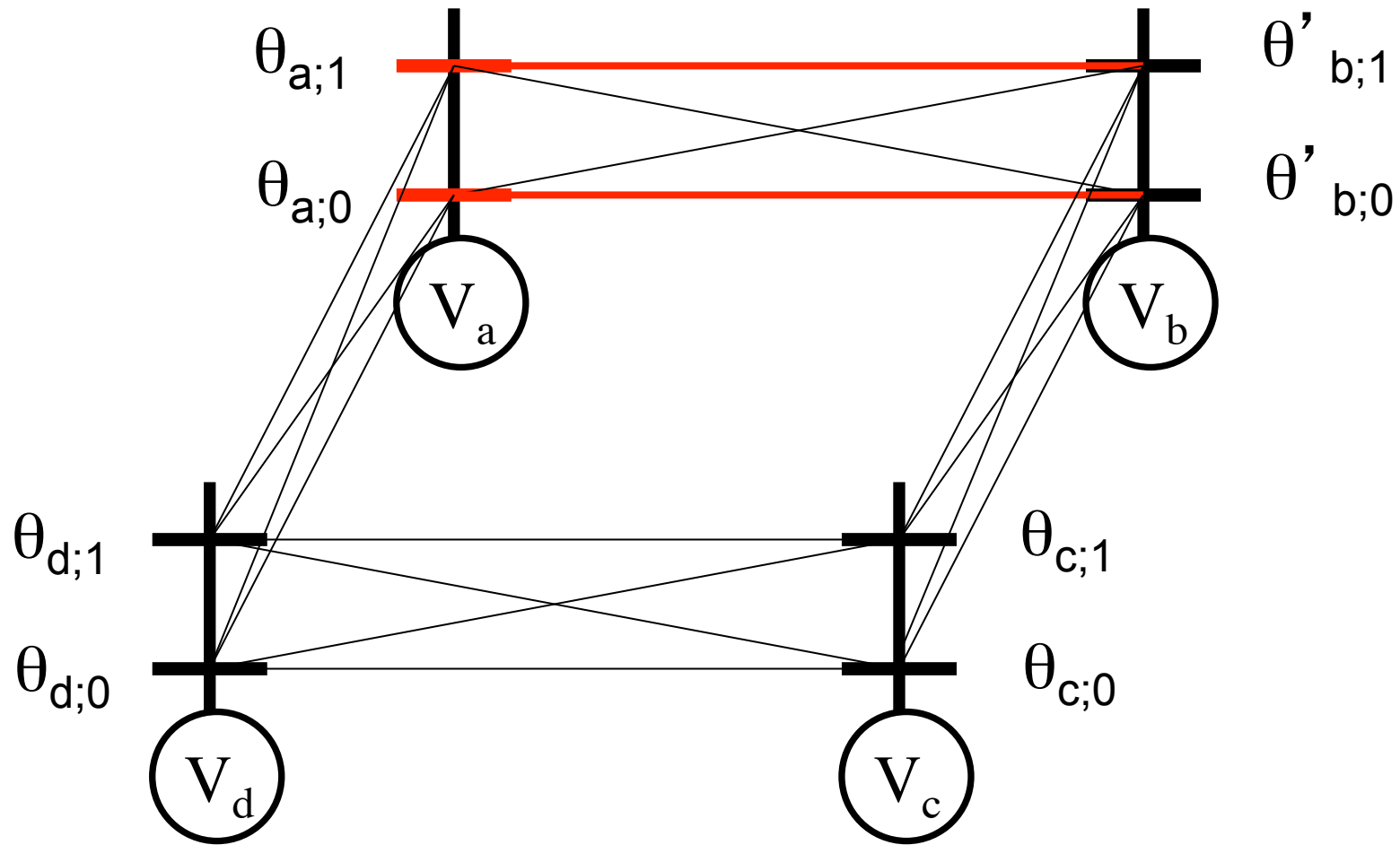

Potentials along the red path add up to 0

Belief Propagation on Cycles

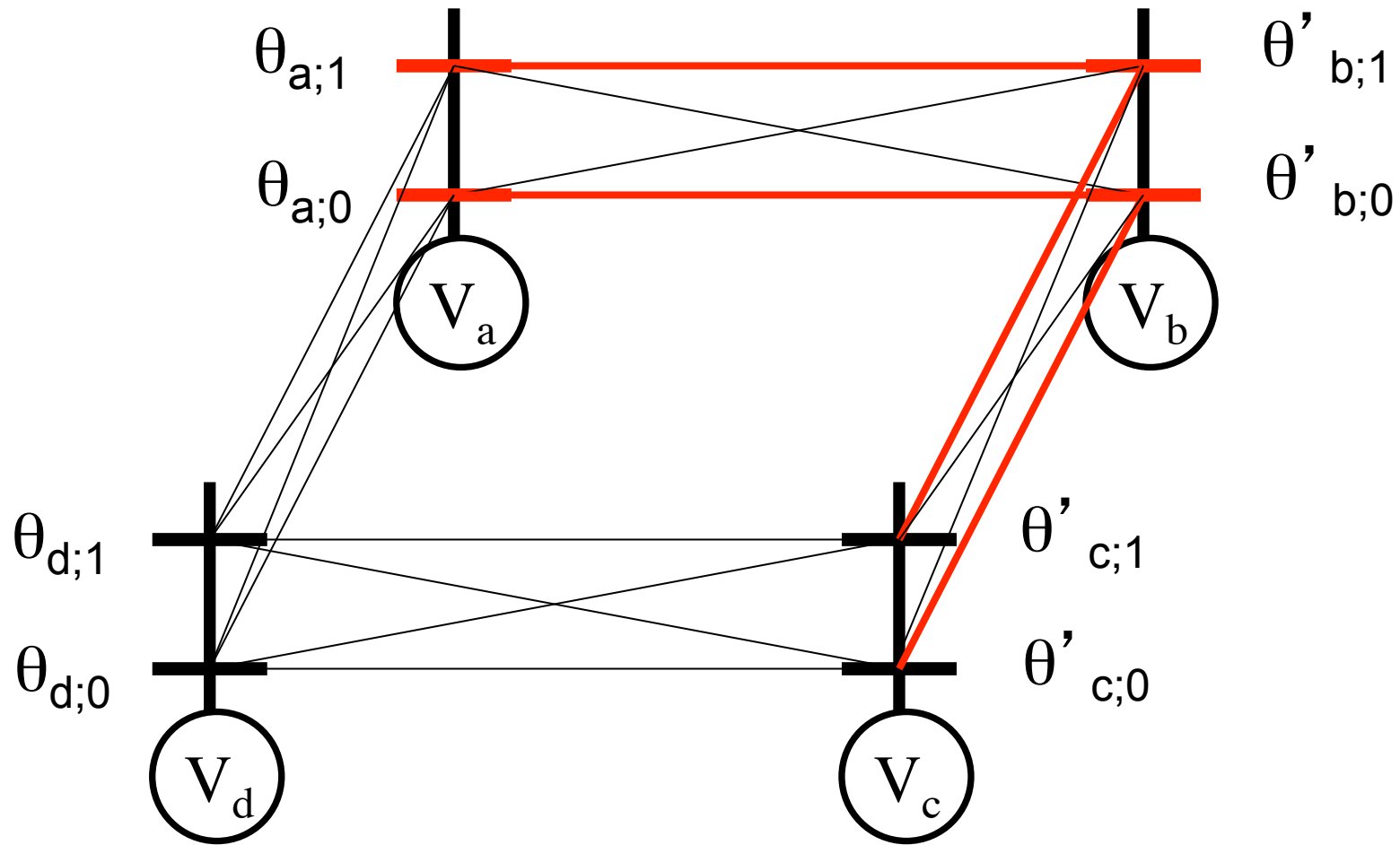

Potentials along the red path add up to 0

Belief Propagation on Cycles

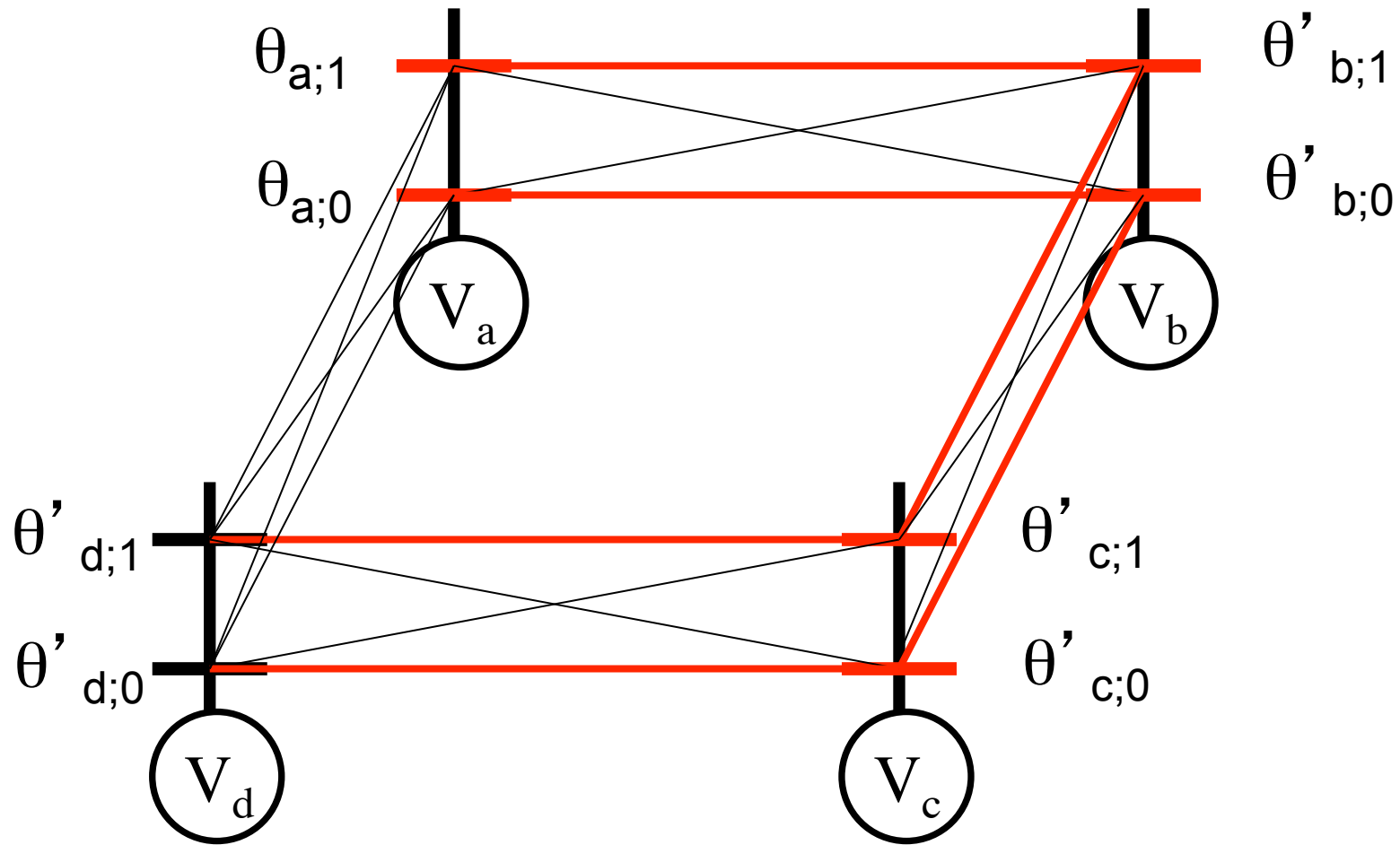

Potentials along the red path add up to 0

Belief Propagation on Cycles

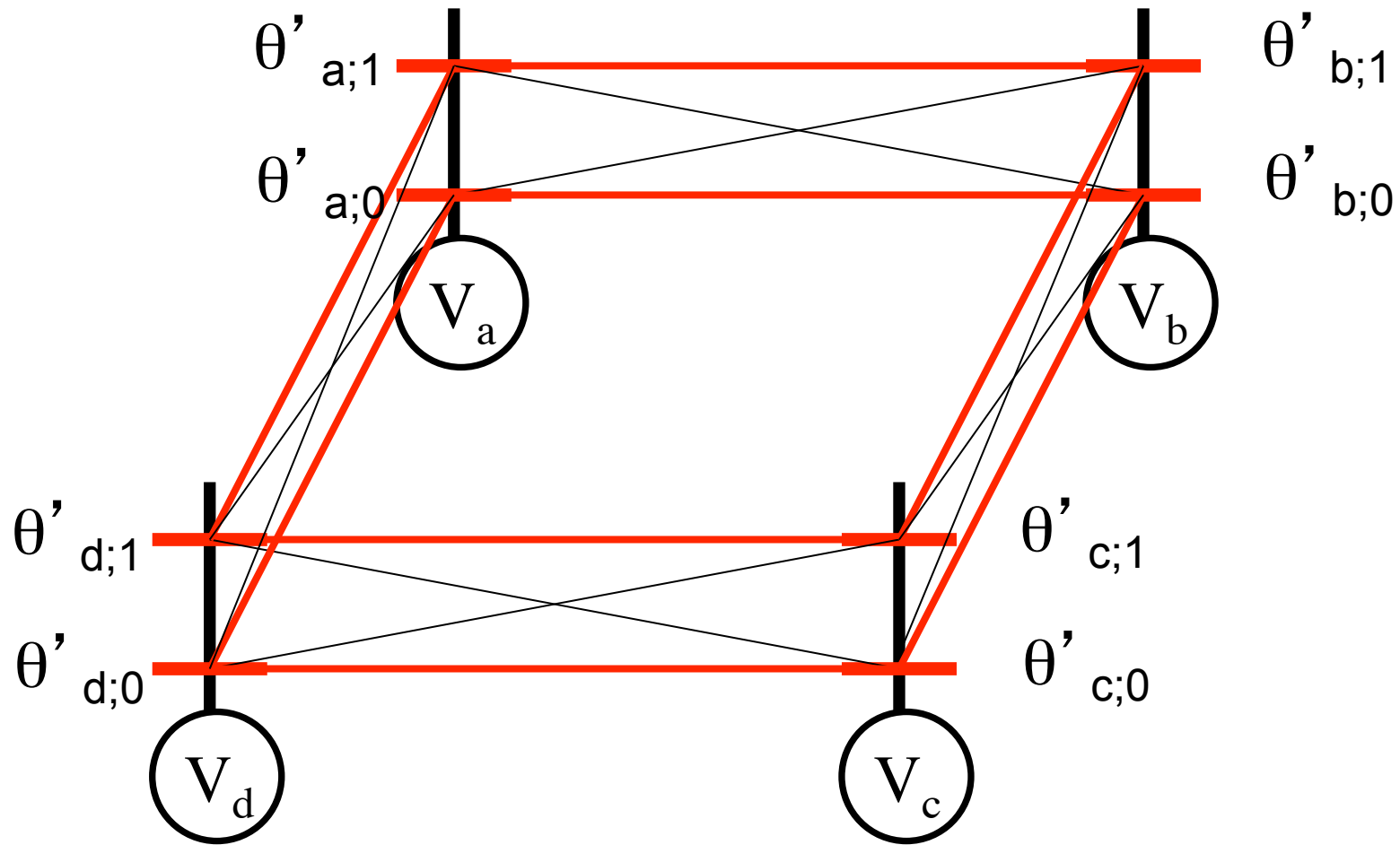

Potentials along the red path add up to 0

Belief Propagation on Cycles

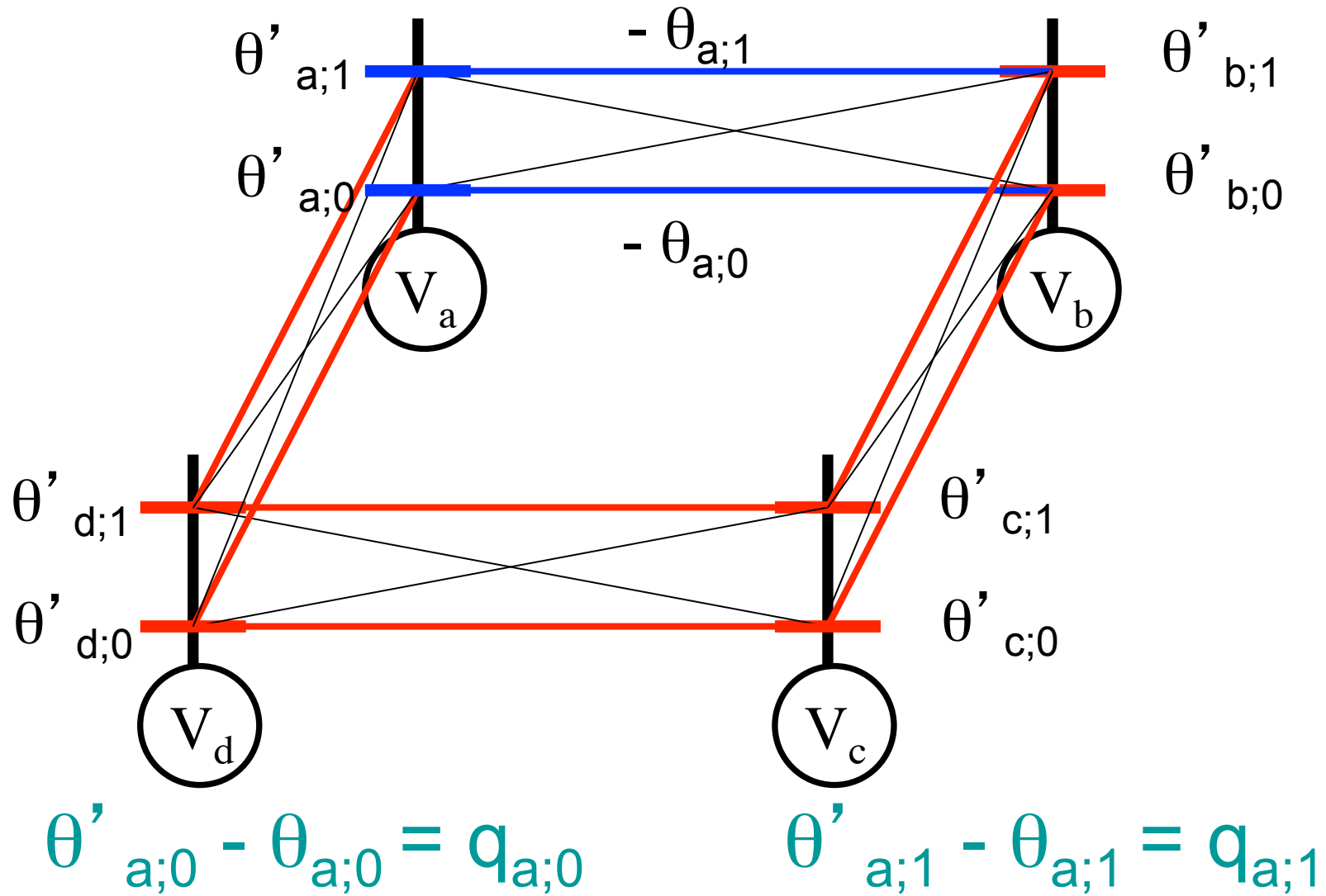

Potentials along the red path add up to 0

Belief Propagation on Cycles

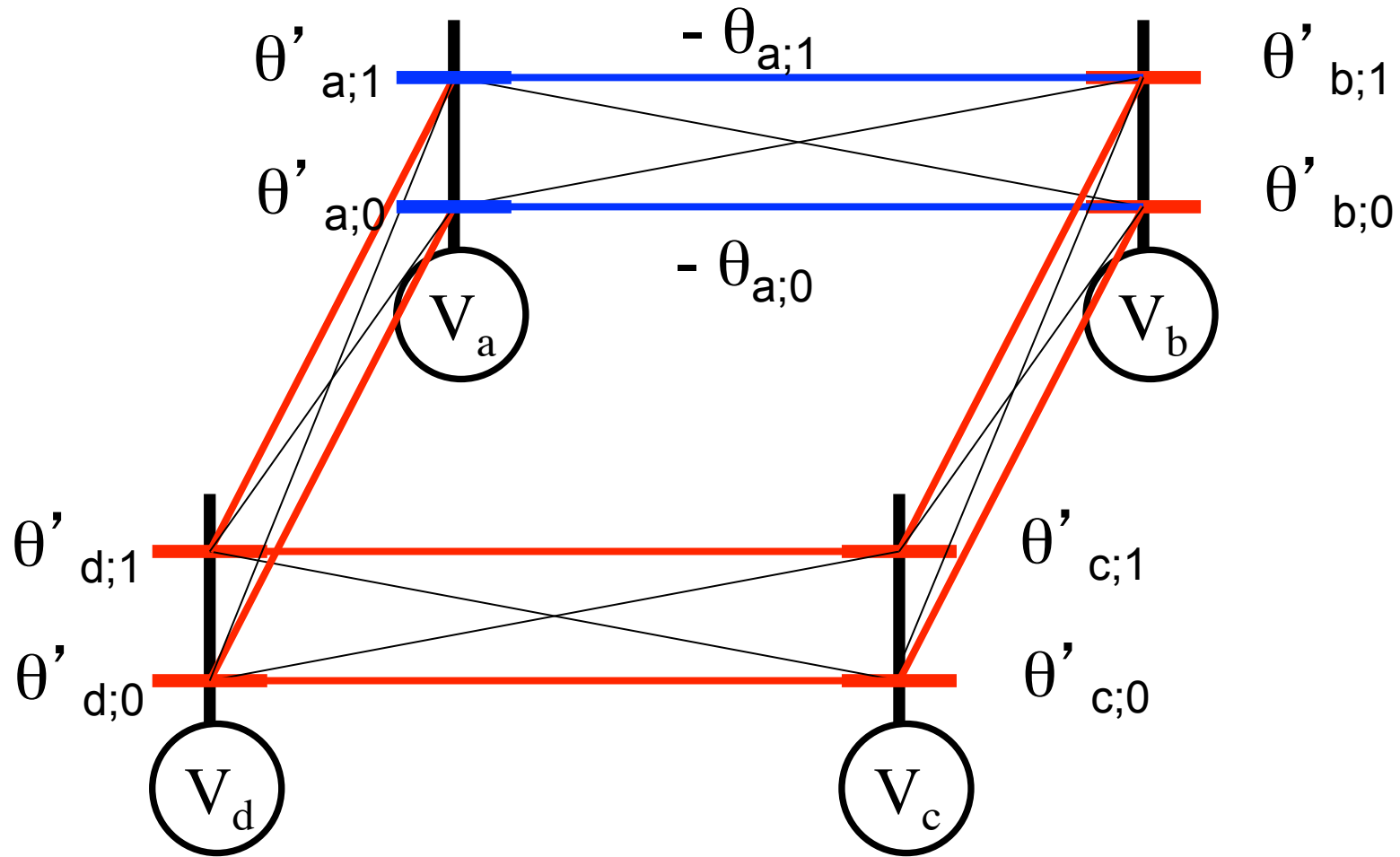

$$\theta'_{a;0} - \theta_{a;0} = q_{a;0}$$

$$\theta'_{a;1} - \theta_{a;1} = q_{a;1}$$

Pick minimum min-marginal. Follow red path.

Belief Propagation on Cycles

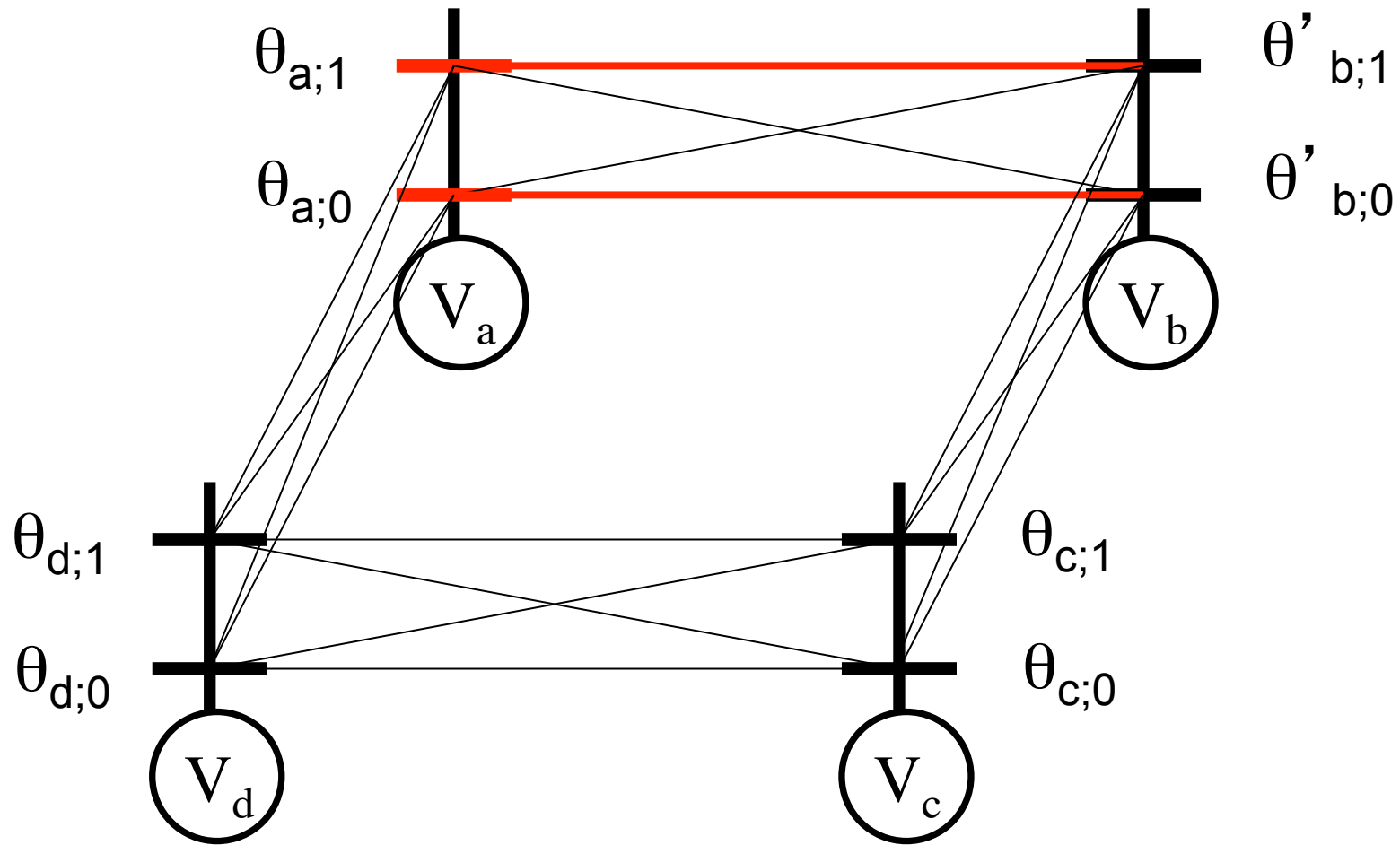

Potentials along the red path add up to 0

Belief Propagation on Cycles

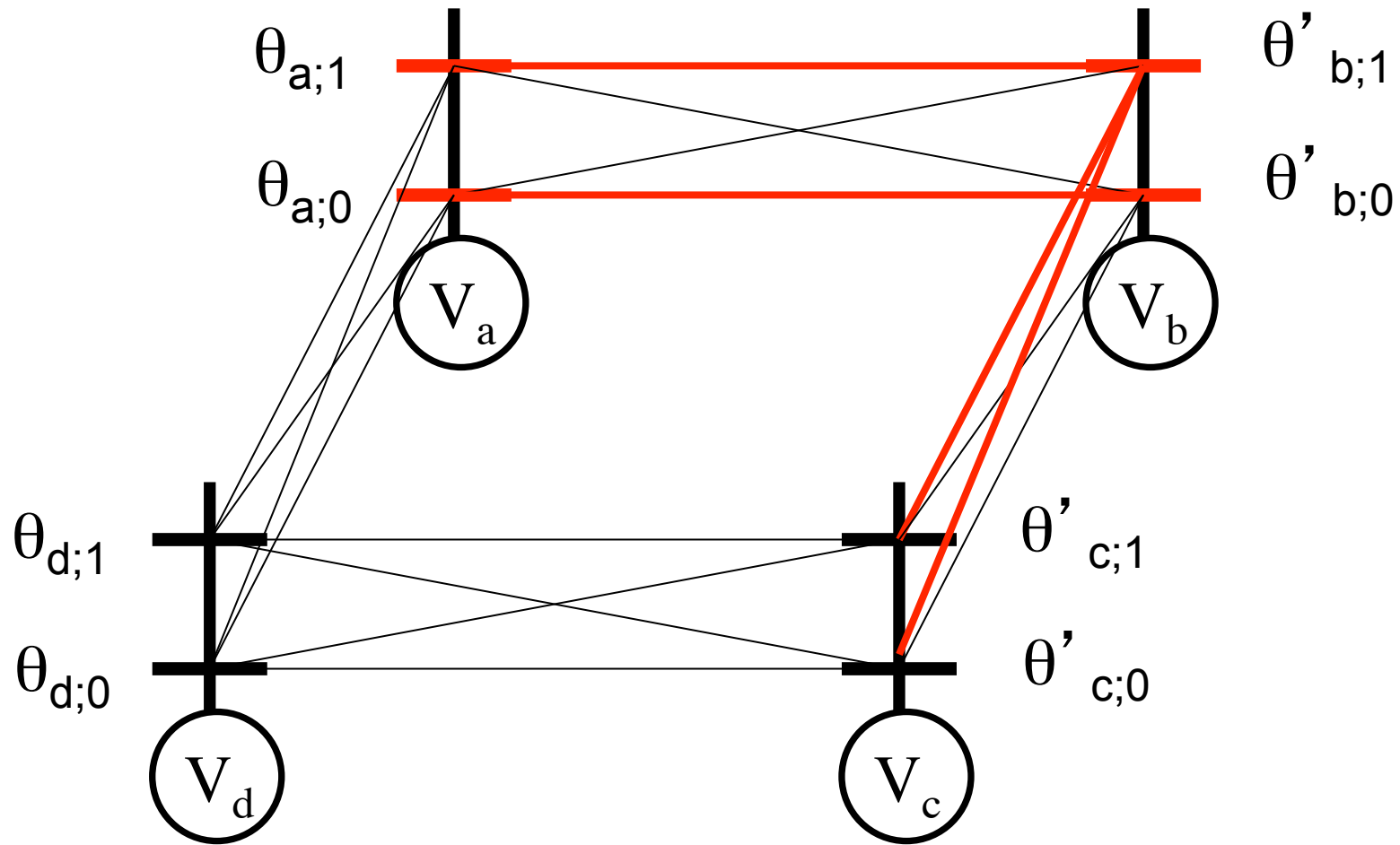

Potentials along the red path add up to 0

Belief Propagation on Cycles

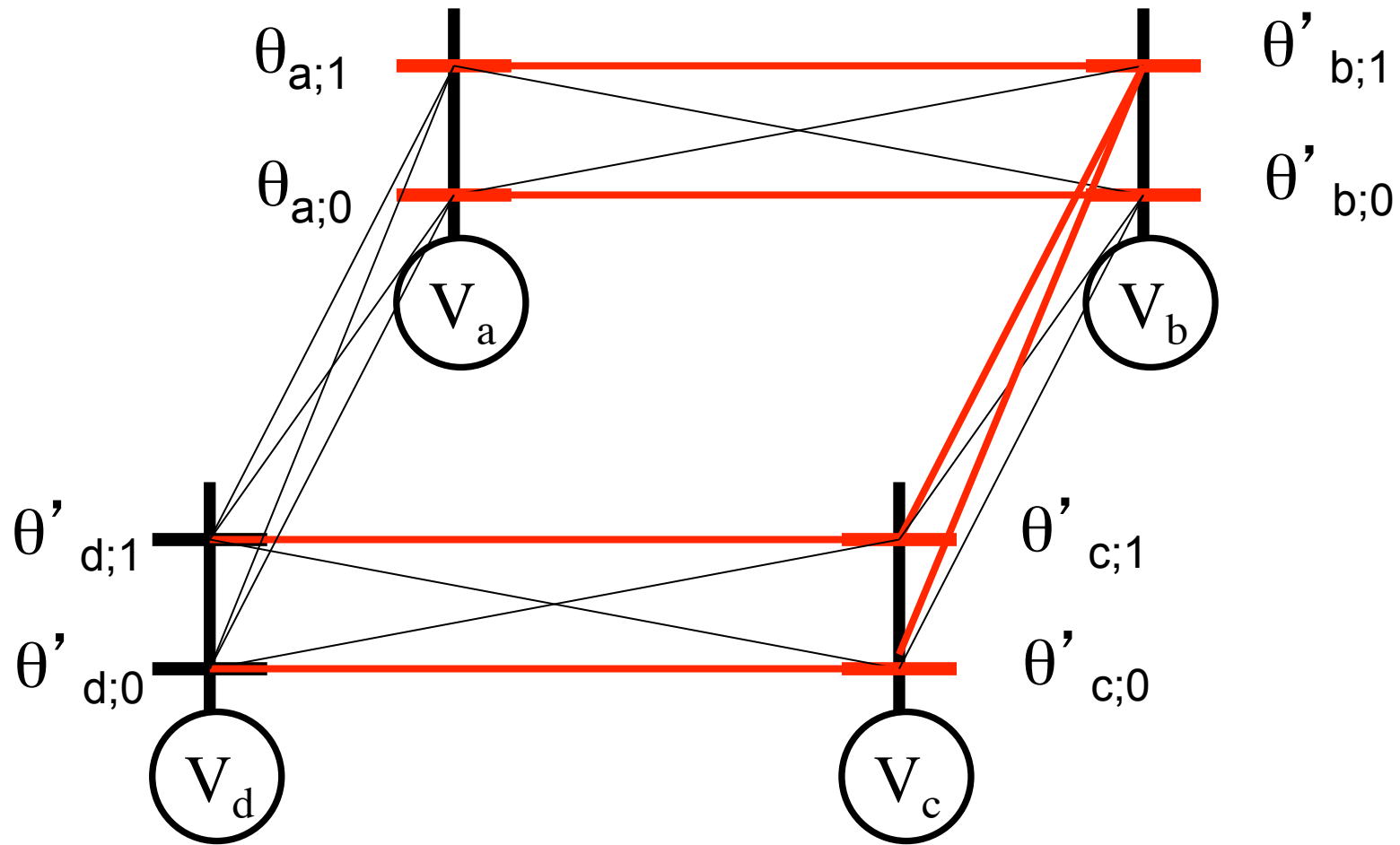

Potentials along the red path add up to 0

Belief Propagation on Cycles

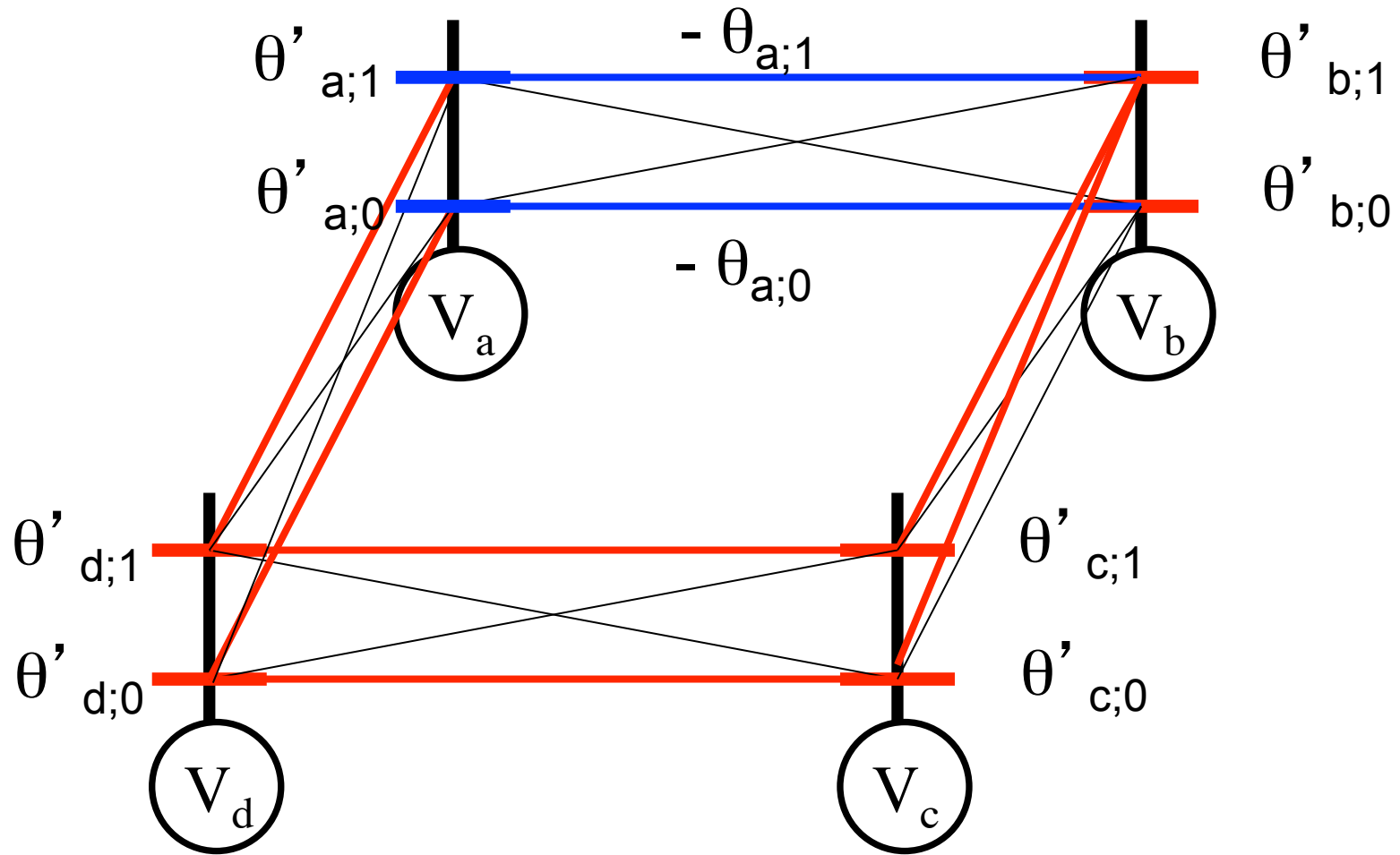

$$\theta'_{a;1} - \theta_{a;1} = q_{a;1} \leq \theta'_{a;0} - \theta_{a;0} = q_{a;0}$$

Potentials along the red path add up to 0

Belief Propagation on Cycles

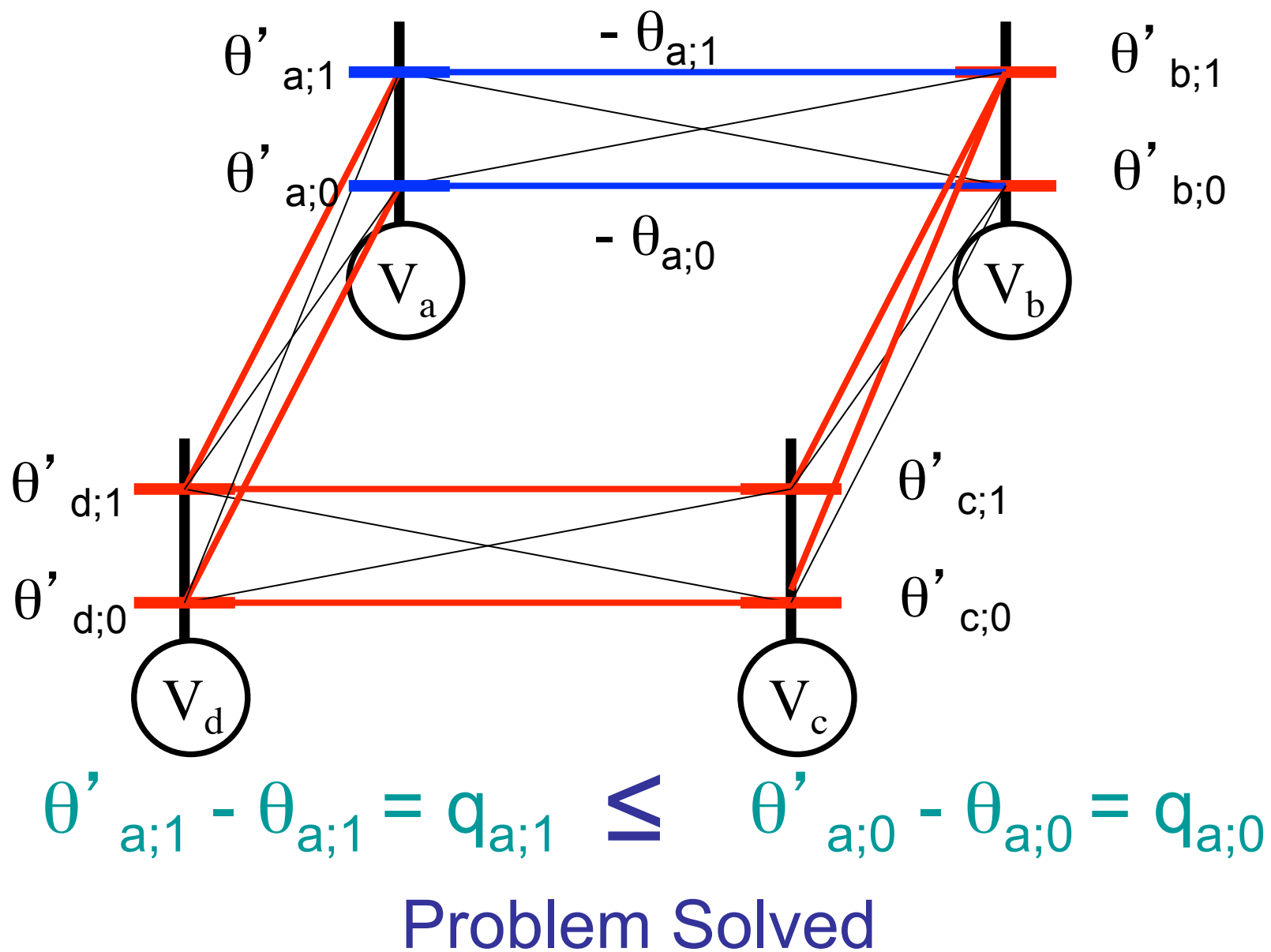

Belief Propagation on Cycles

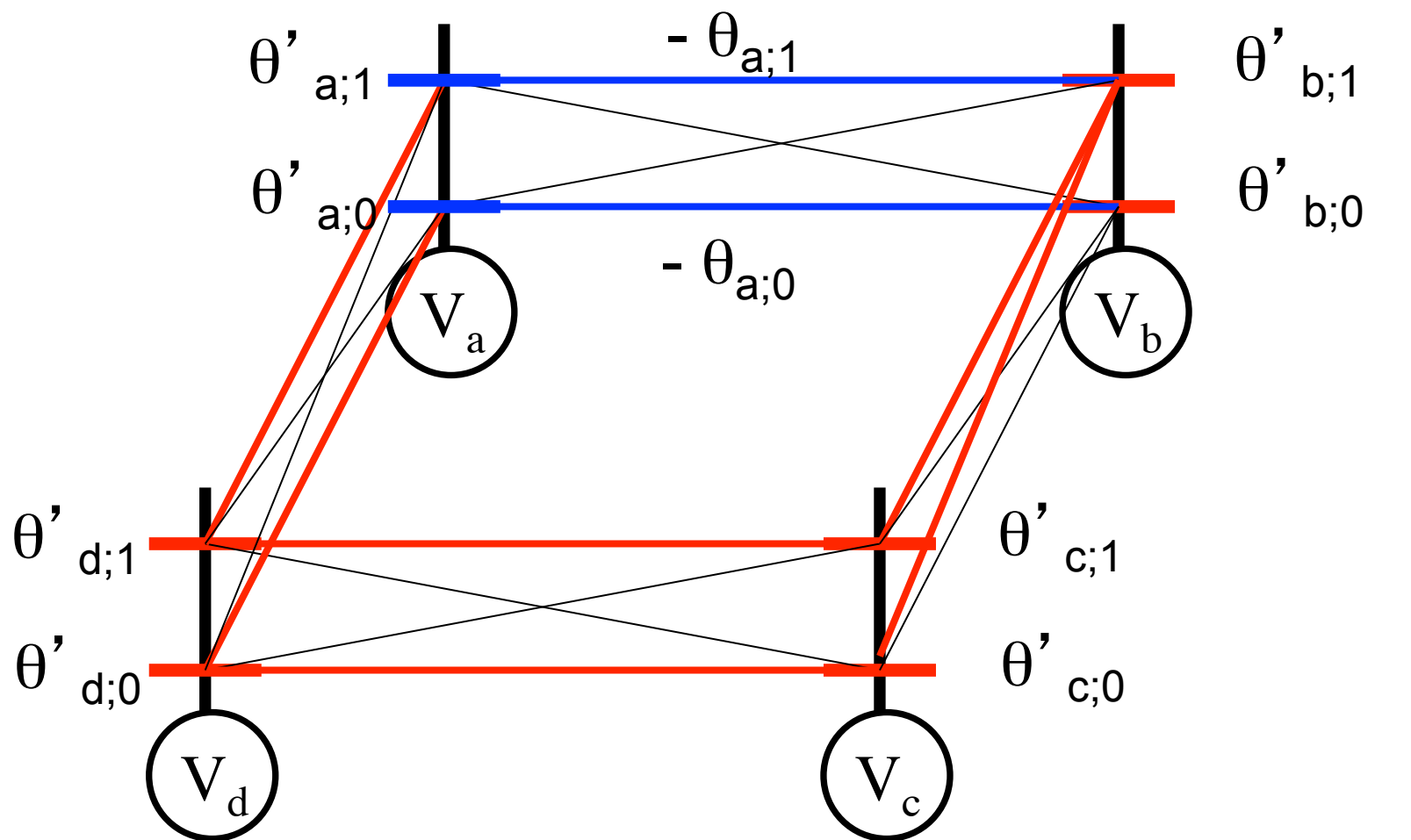

$$\theta'_{a;1} - \theta_{a;1} = q_{a;1} \geq \theta'_{a;0} - \theta_{a;0} = q_{a;0}$$

Problem Not Solved

Belief Propagation on Cycles

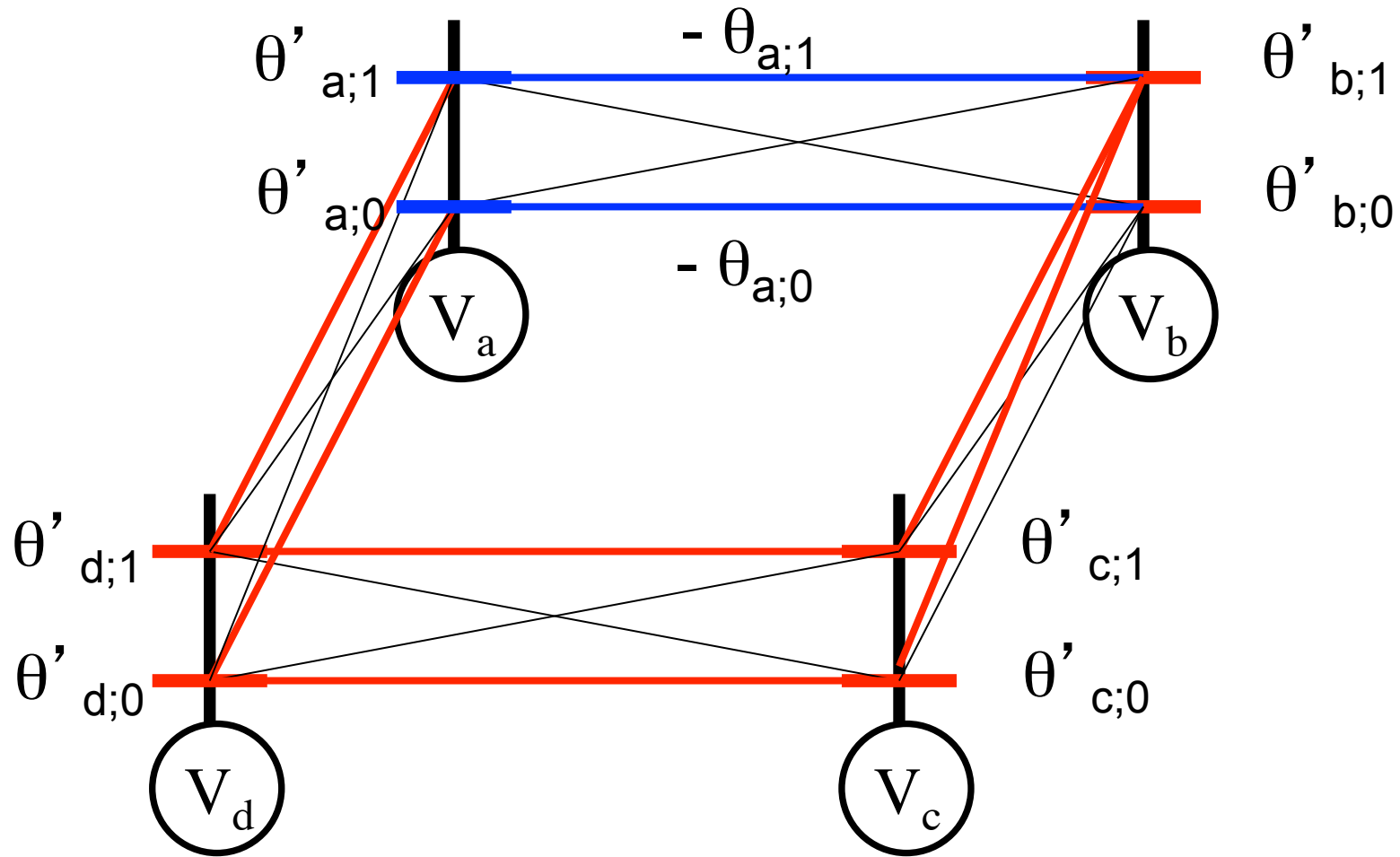

Reparameterize (a,b) again

Belief Propagation on Cycles

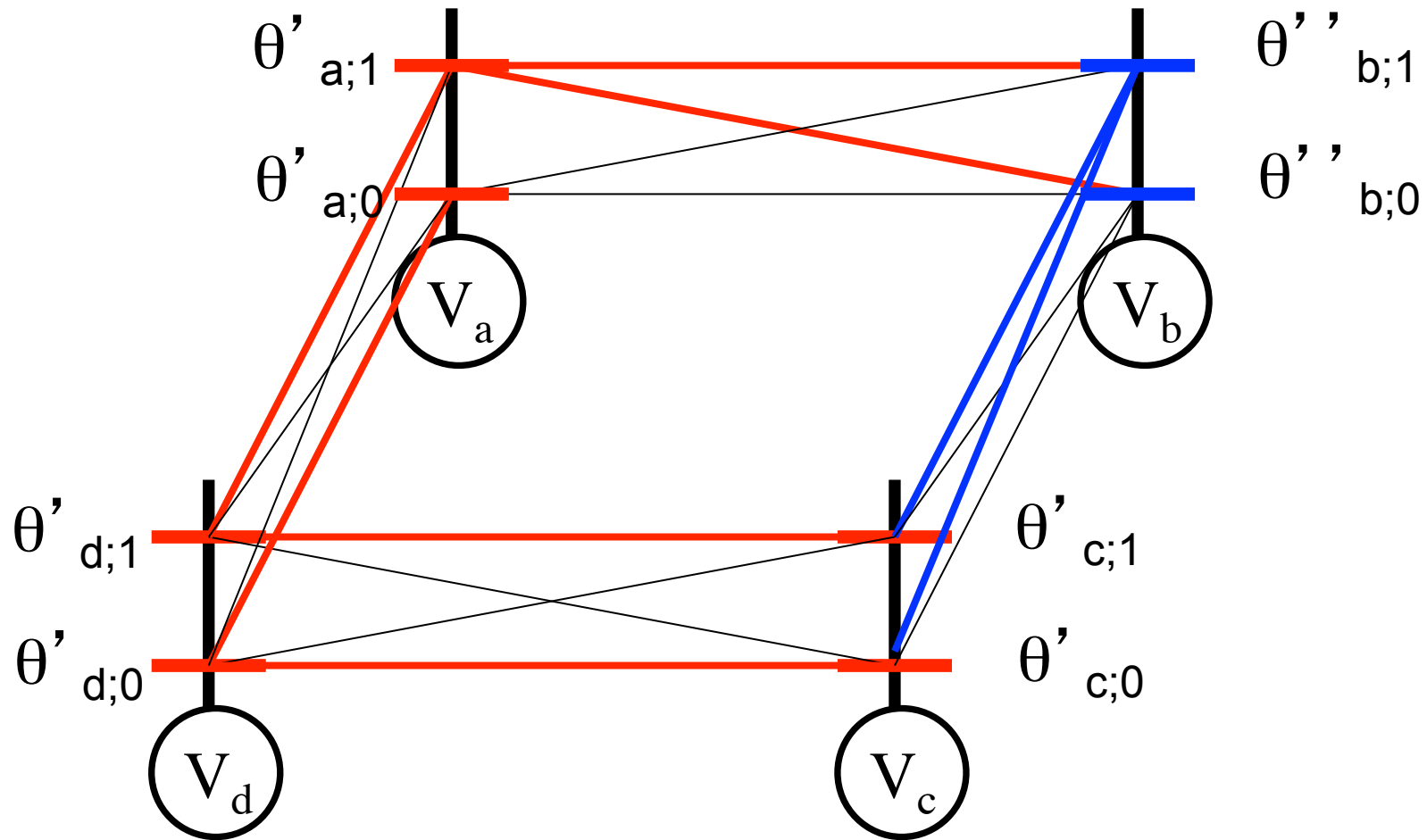

Reparameterize (a,b) again

But doesn't this overcount some potentials?

Belief Propagation on Cycles

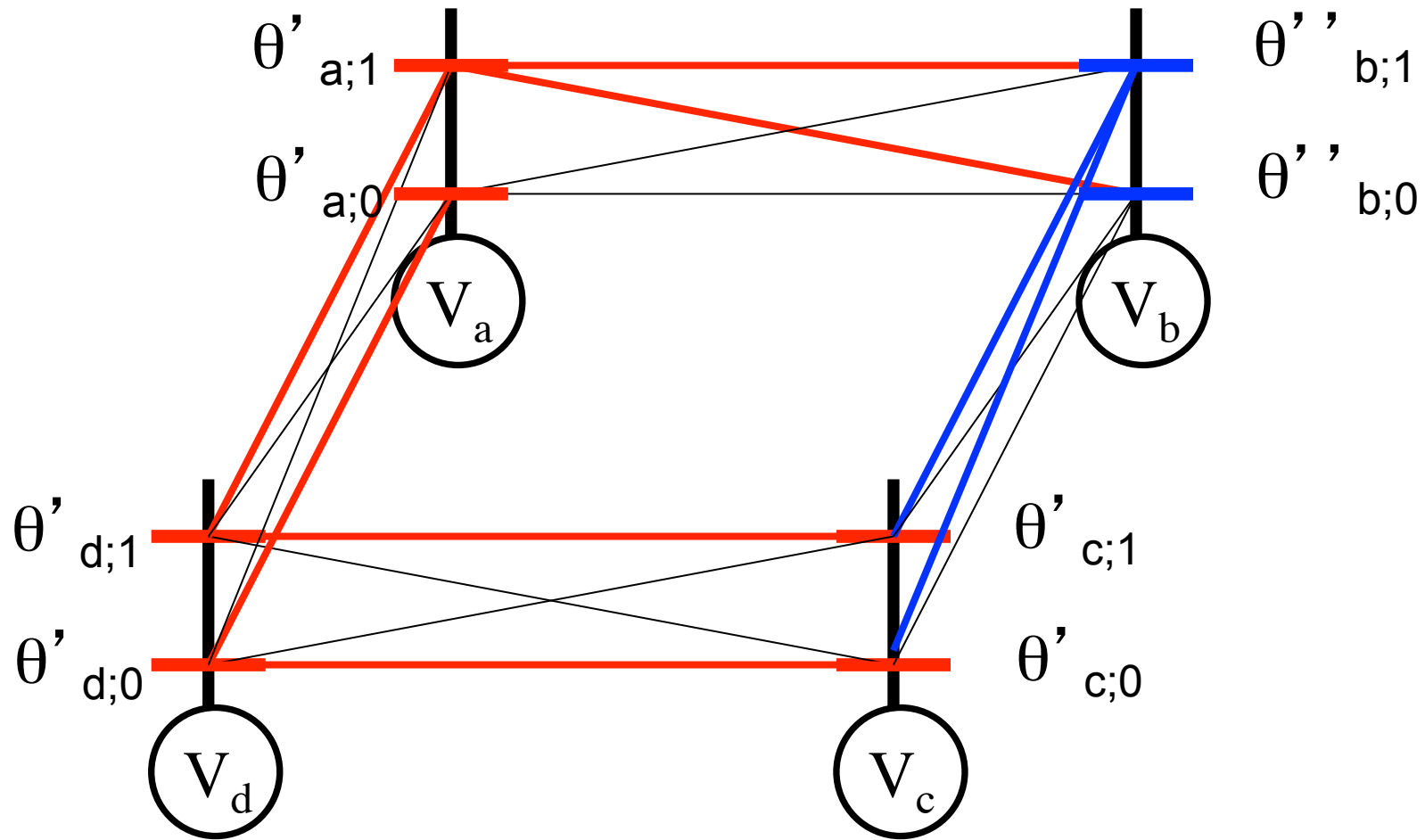

Reparameterize (a,b) again

Yes. But we will do it anyway

Belief Propagation on Cycles

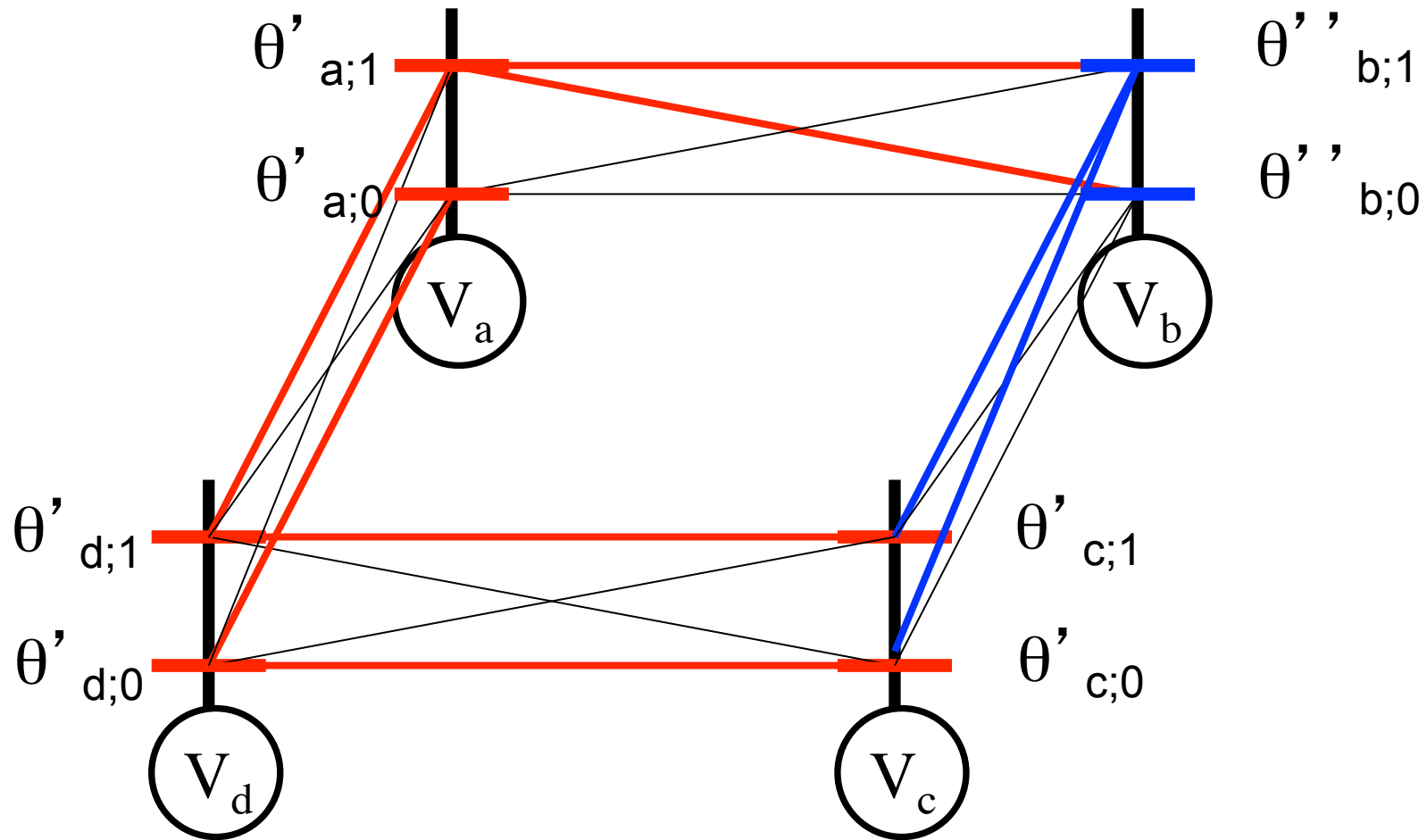

Keep reparameterizing edges in some order

Hope for convergence and a good solution

Belief Propagation on Cycles

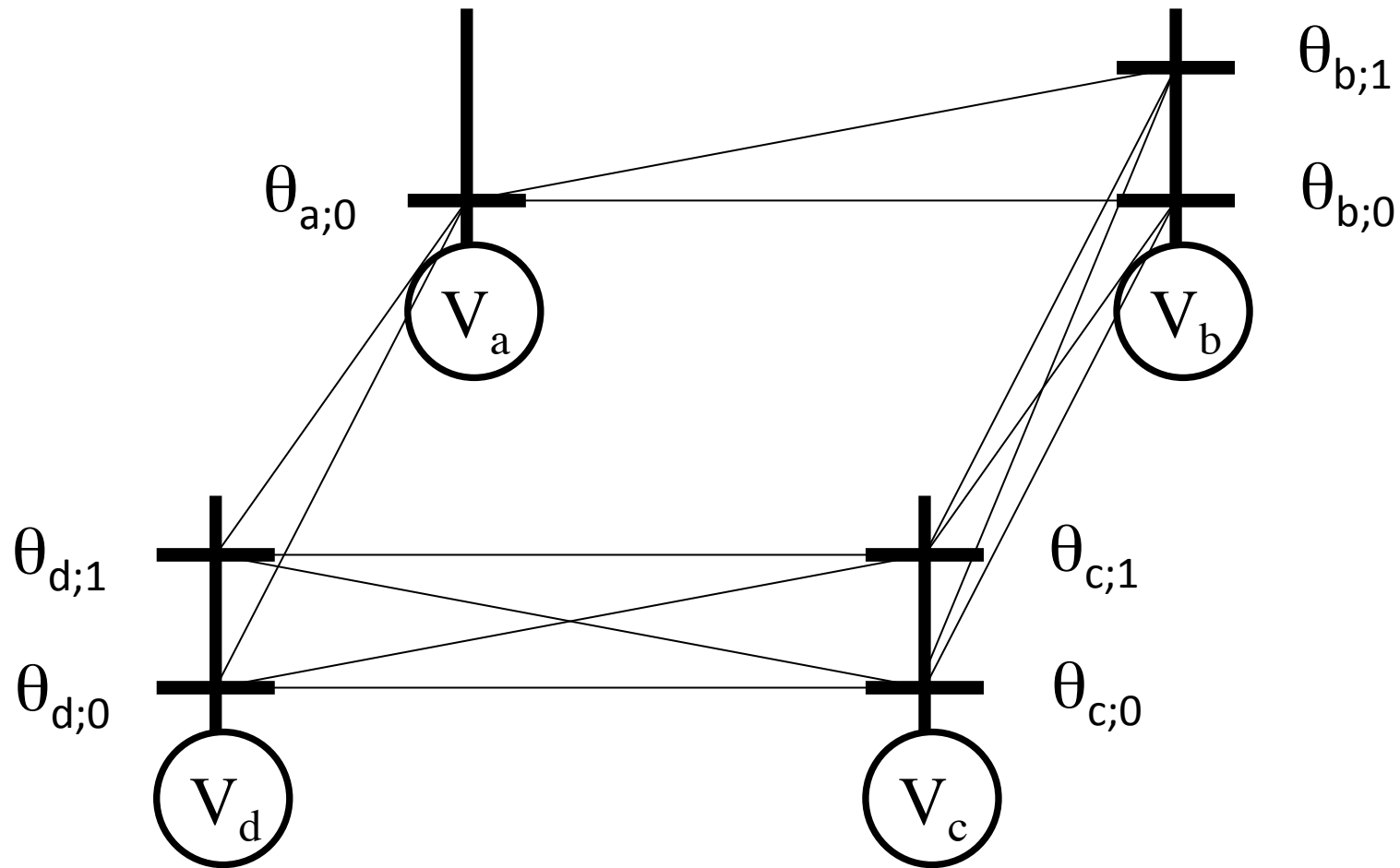

Any suggestions?

Fix V_a to label l_0

Equivalent to a tree-structured problem

Belief Propagation on Cycles

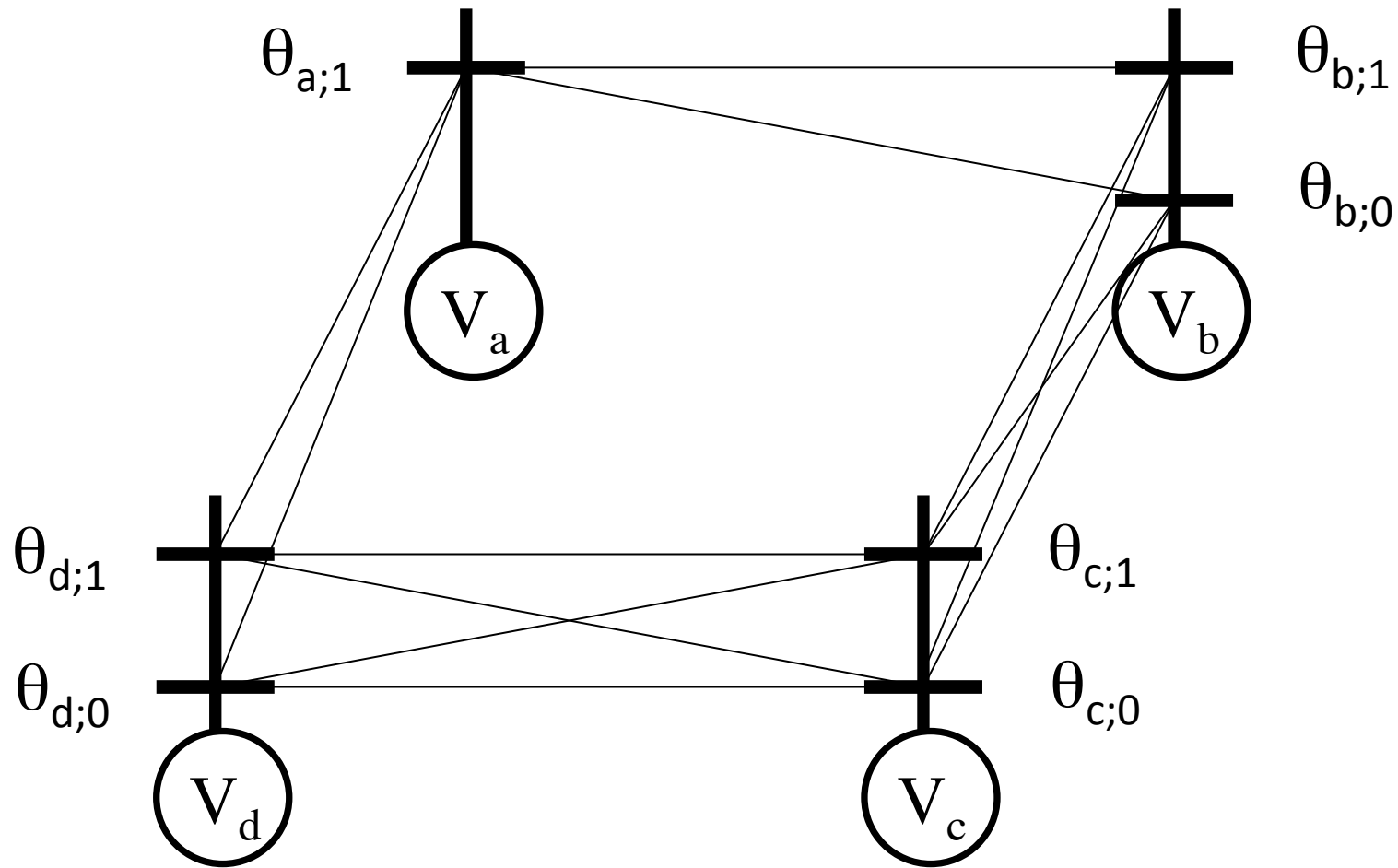

Any suggestions?

Fix V_a to label l_1

Equivalent to a tree-structured problem

Belief Propagation on Cycles

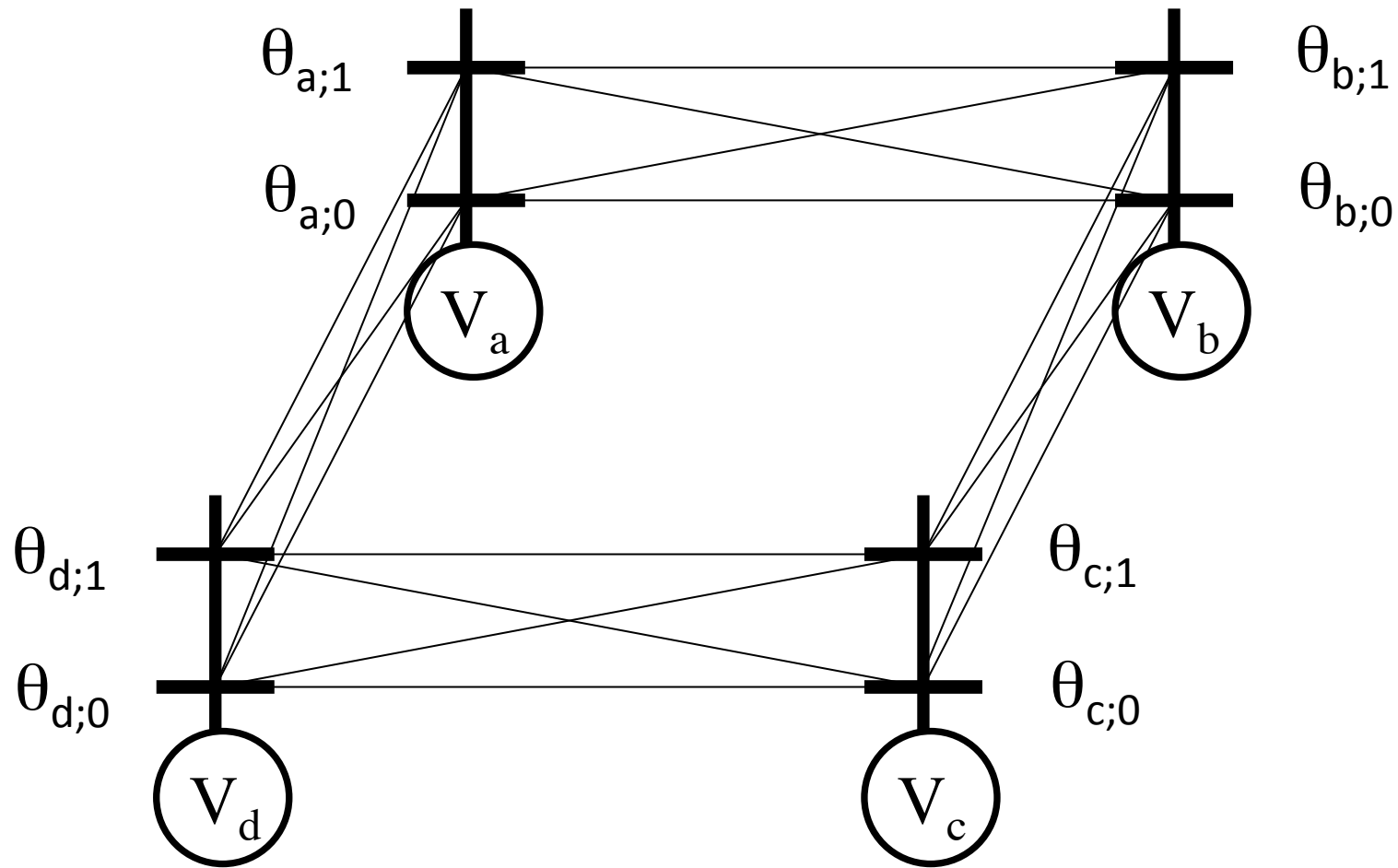

This approach quickly becomes infeasible

Choose the minimum energy solution

Loopy Belief Propagation

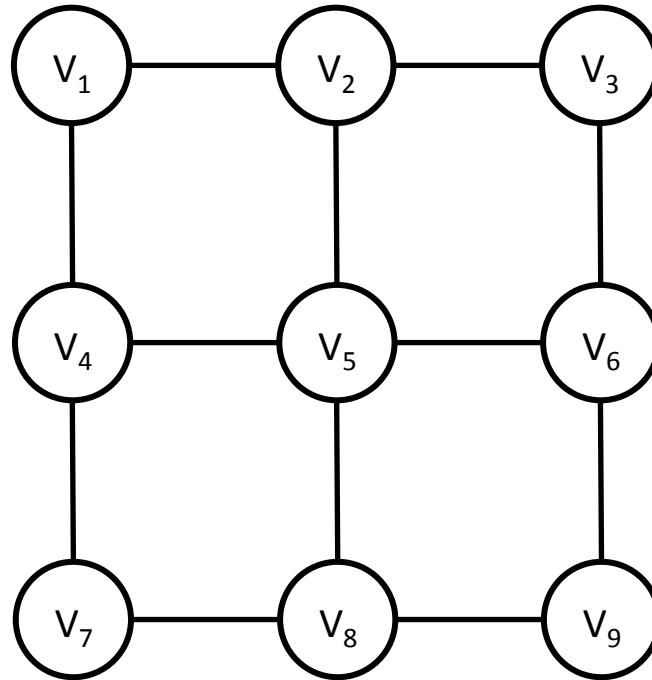

Keep reparameterizing edges in some order

Hope for convergence and a good solution

Belief Propagation

- Generalizes to any arbitrary random field
- Complexity per iteration ?

$$O(|E||L|^2)$$

- Memory required ?

$$O(|E||L|)$$

Summary of BP

Exact for chains

Exact for trees

Approximate MAP for general cases

Not even convergence guaranteed

So can we do something better?

Other alternatives

- Integer linear programming and relaxation
- TRW, Dual decomposition methods
- Extensively studied
 - Schlesinger, 1976
 - Koster et al., 1998, Chekuri et al., '01, Archer et al., '04
 - Wainwright et al., 2001, Kolmogorov, 2006
 - Globerson and Jaakkola, 2007, Komodakis et al., 2007
 - Kumar et al., 2007, Sontag et al., 2008, Werner, 2008
 - Batra et al., 2011, Werner, 2011, Zivny et al., 2014

Where do we stand ?

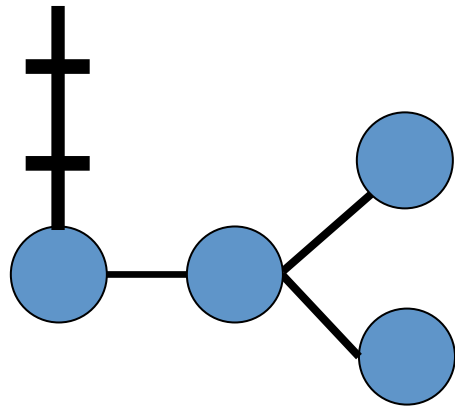

Chain/Tree, 2-label:

Use BP

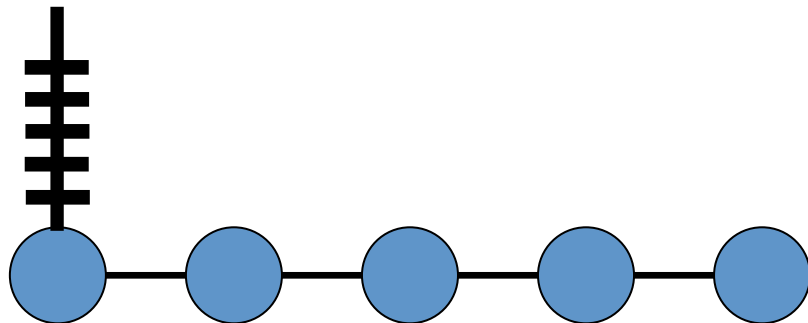

Chain/Tree, multi-label:

Use BP

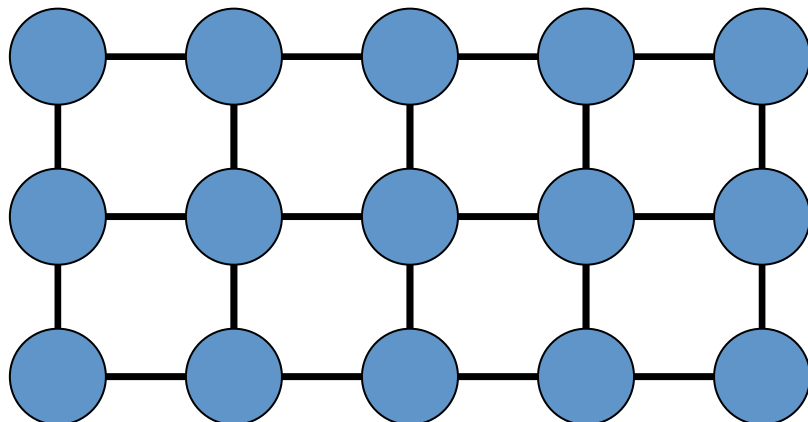

Grid graph:

Use TRW,
dual decomposition,
relaxation